

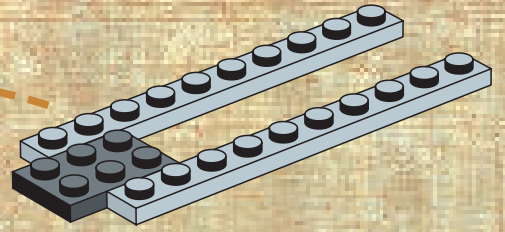



1



2

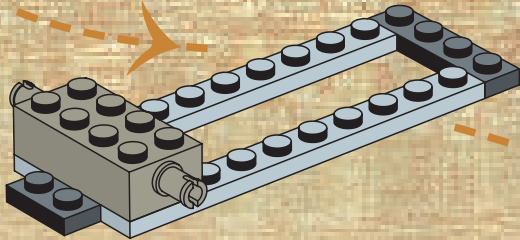

3

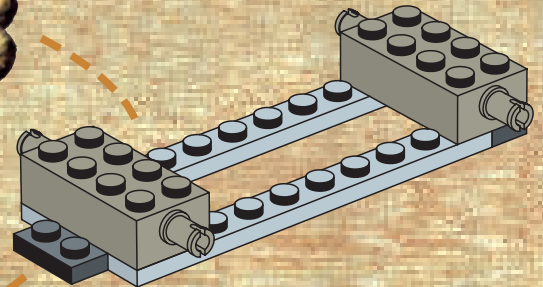

4

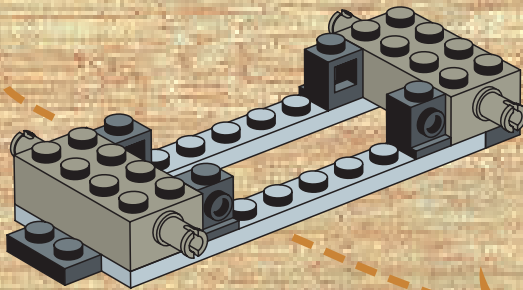

5

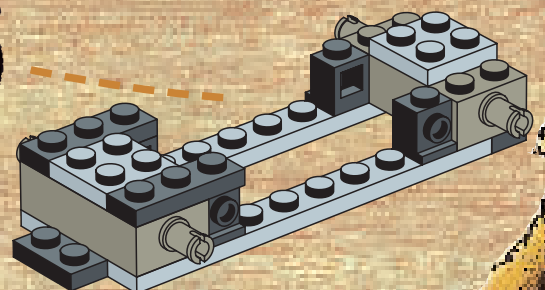



6

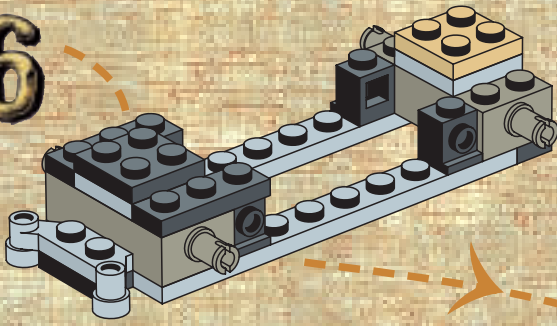

7

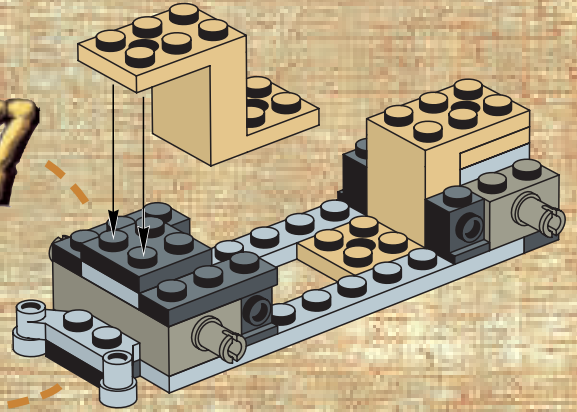

8

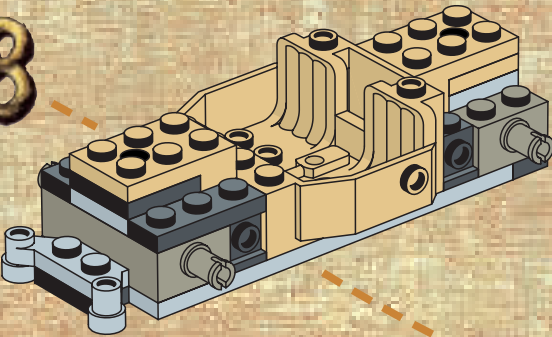

9

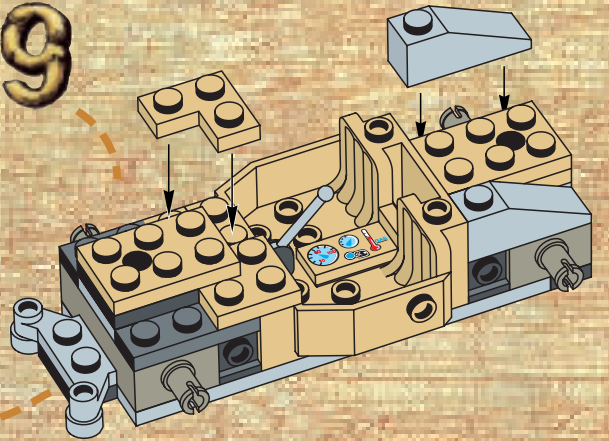

10

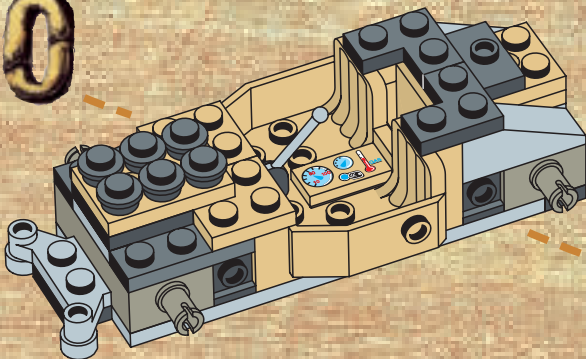



11

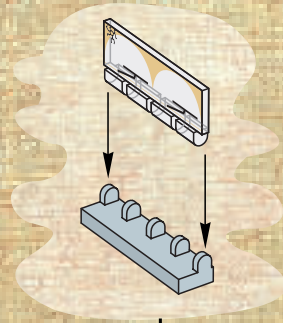
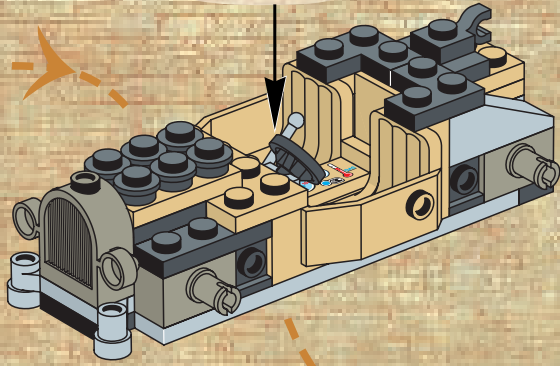

12

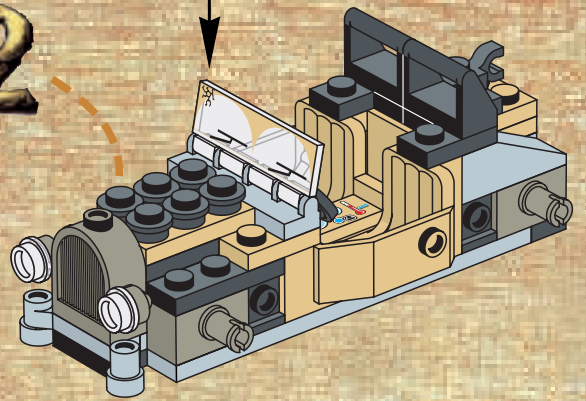

13

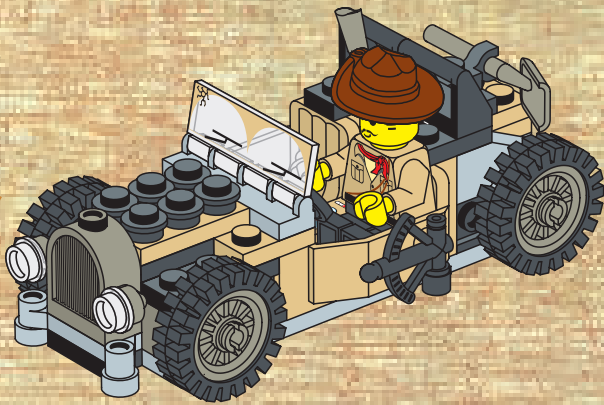



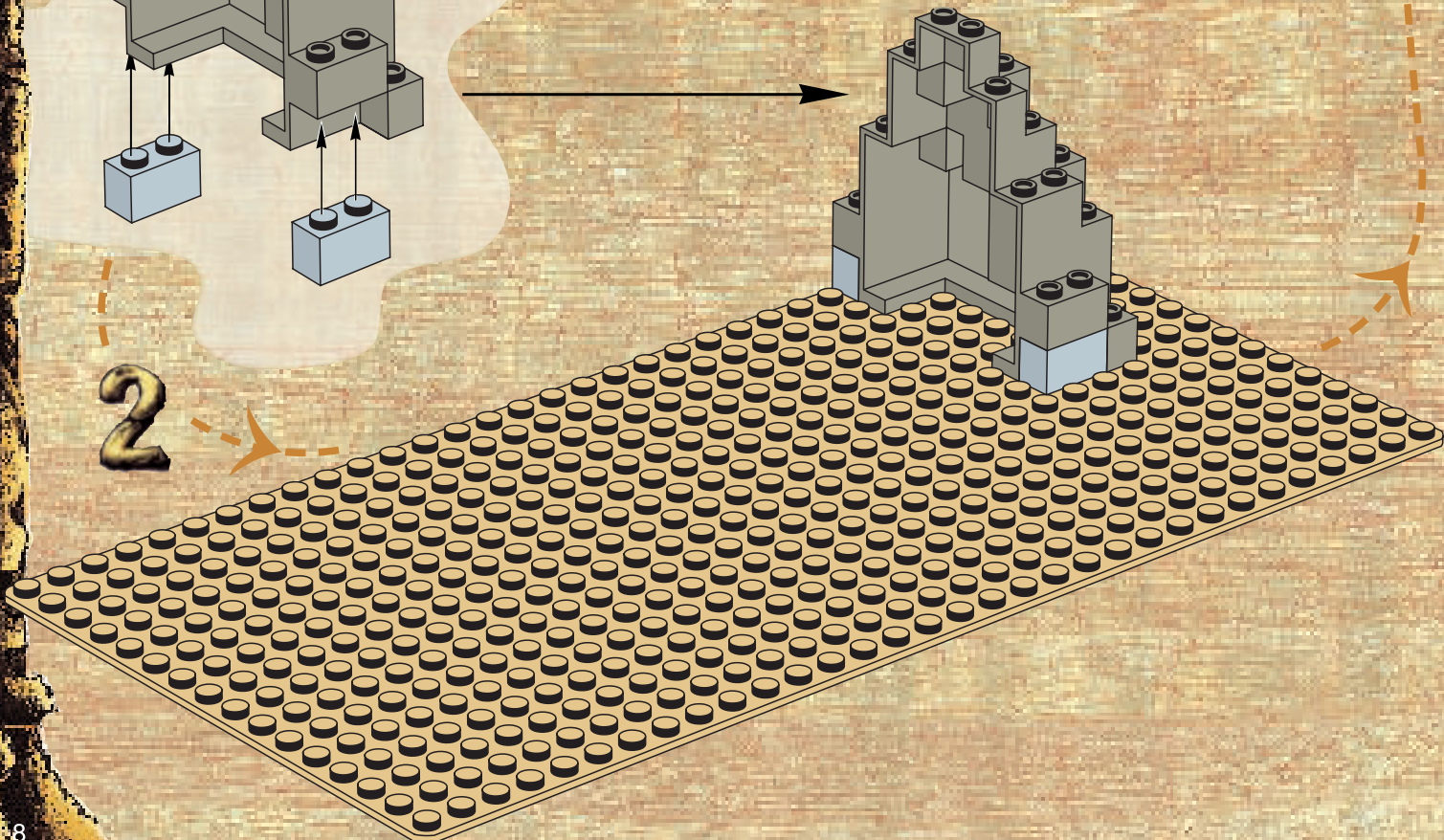
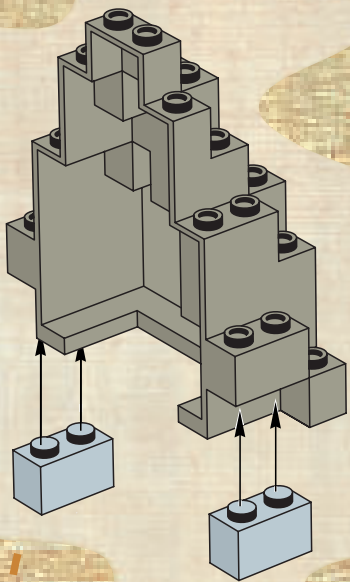
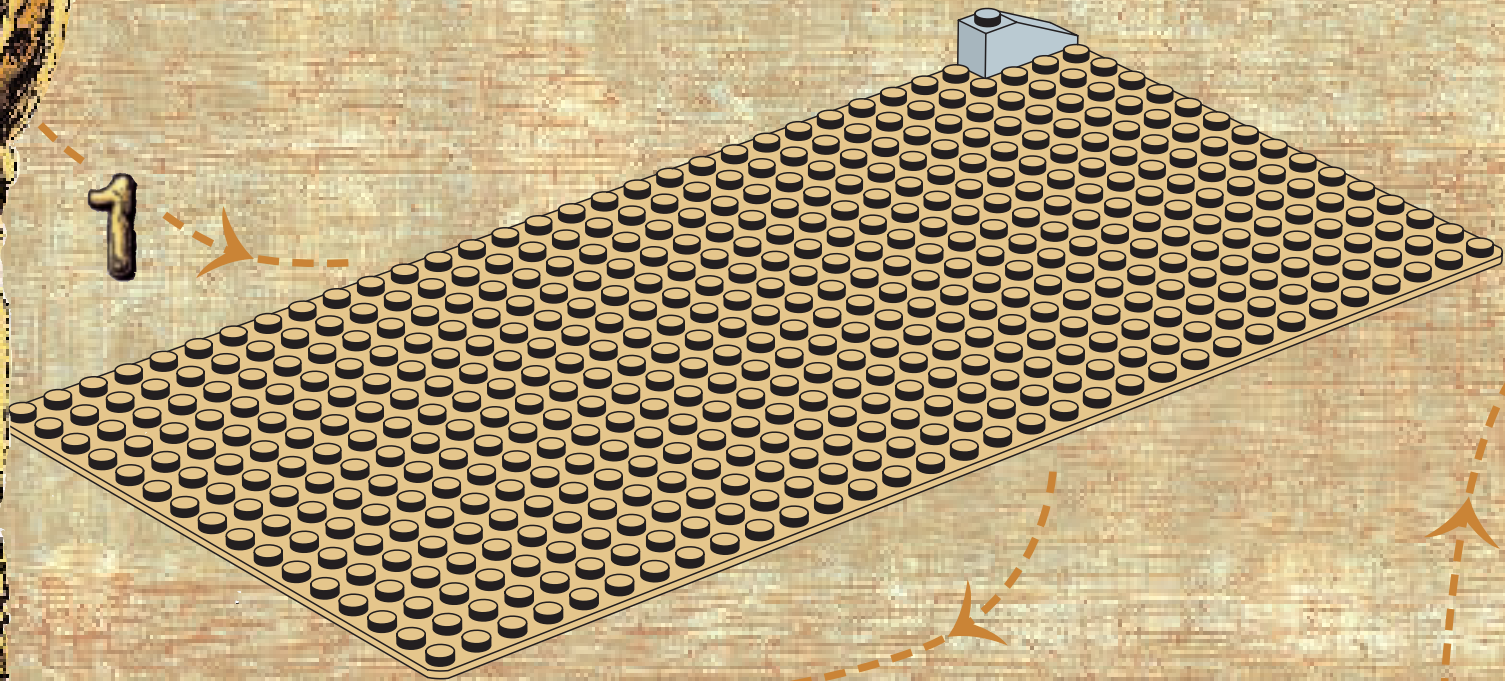



3

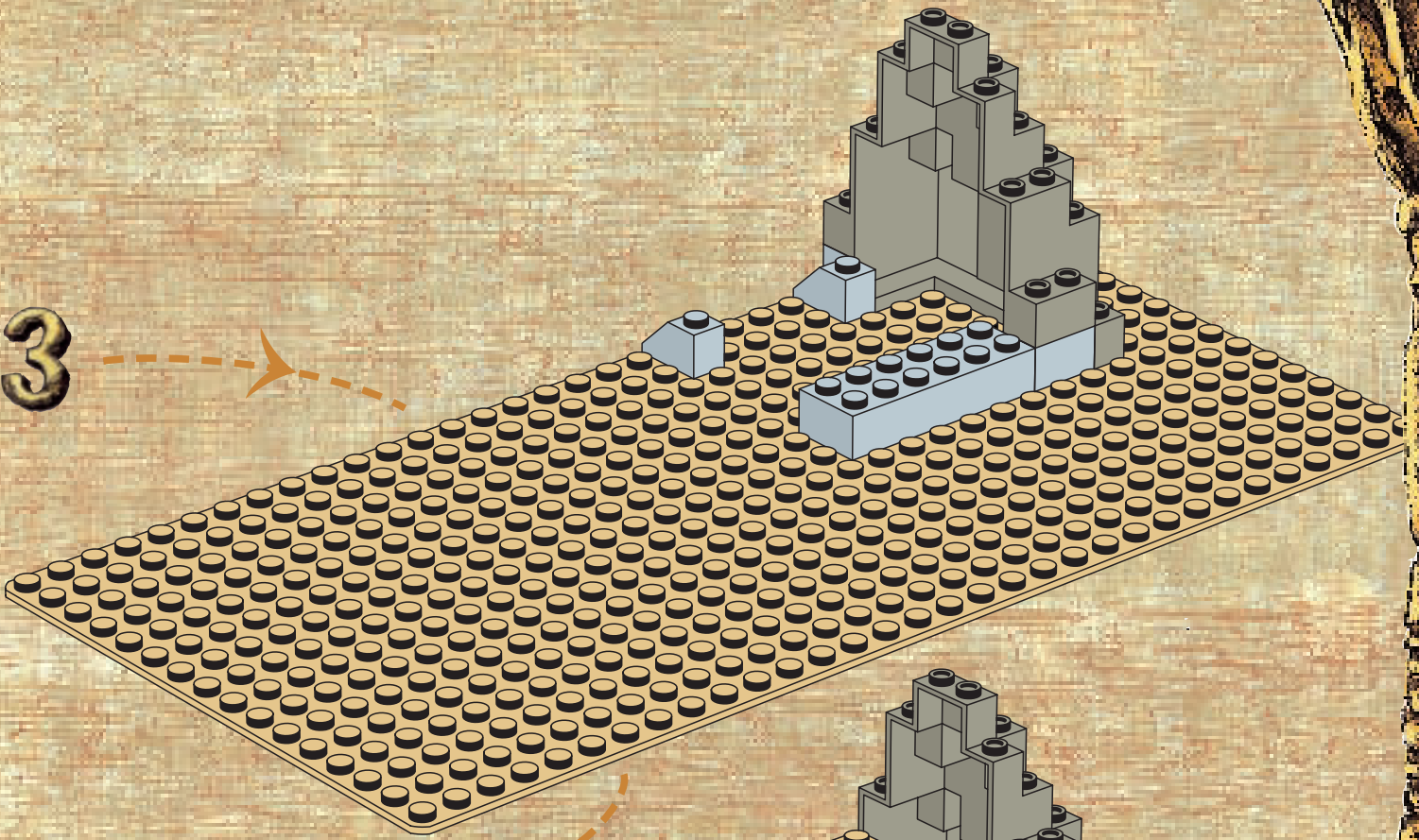

4

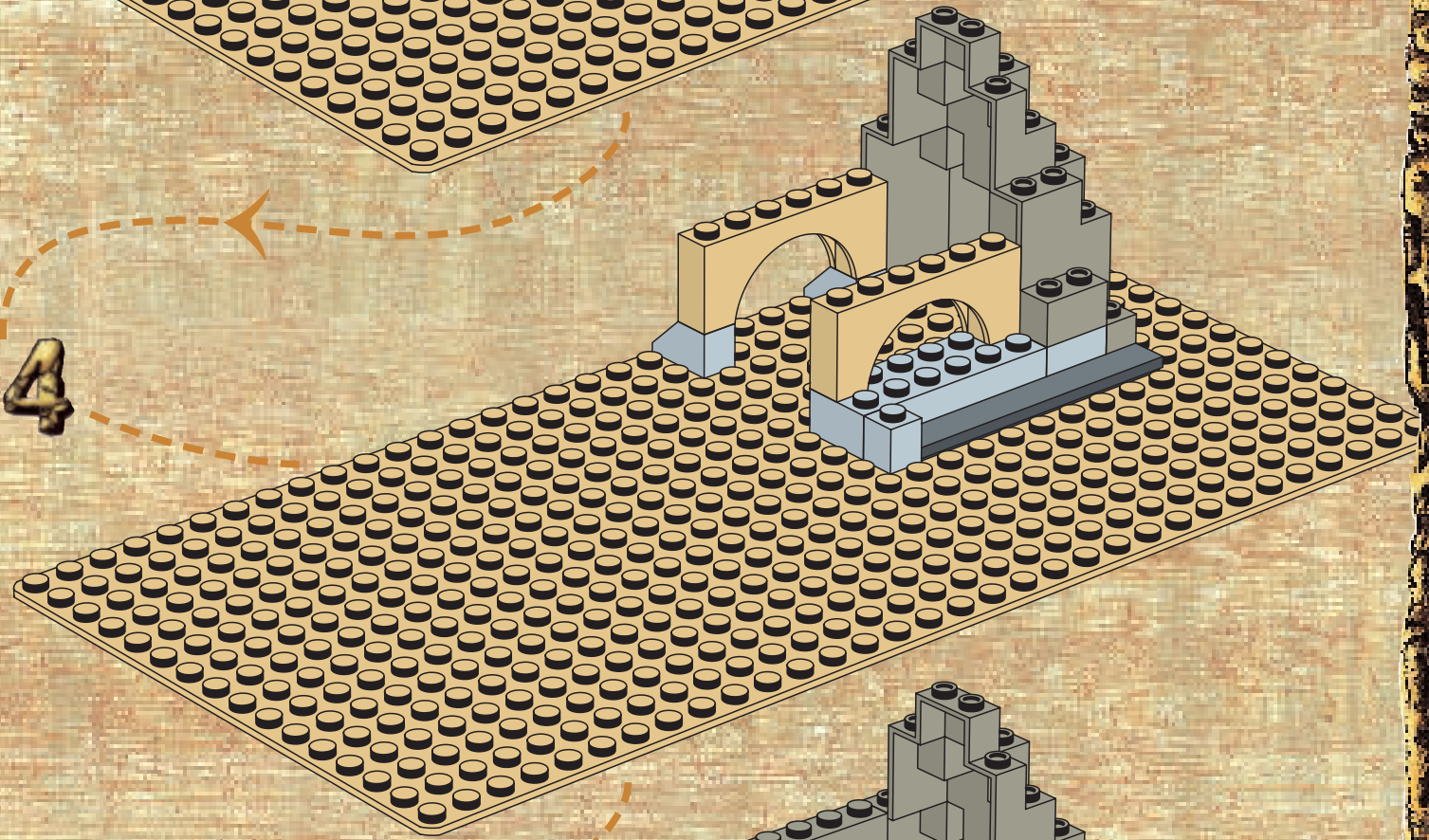

5

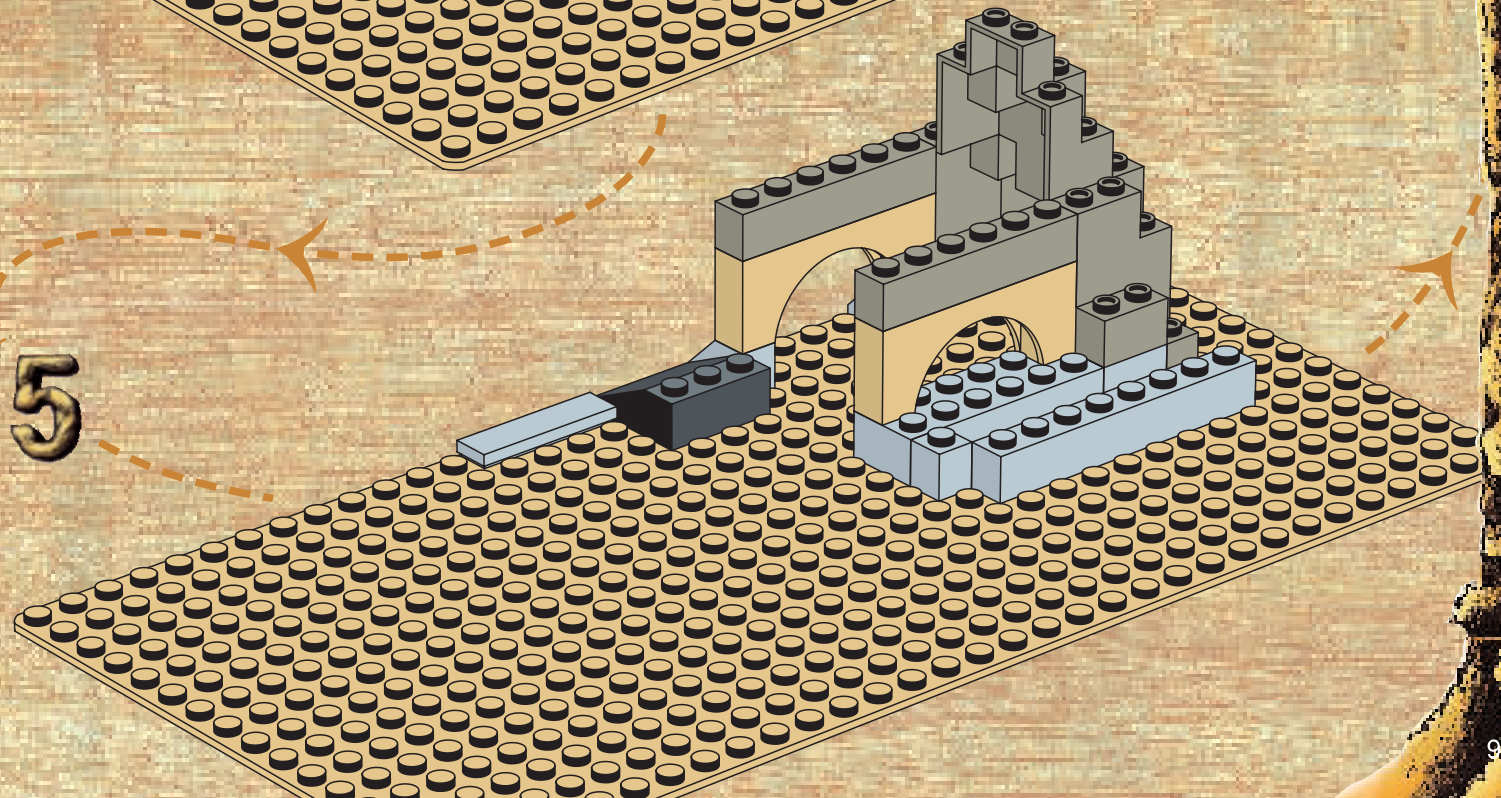



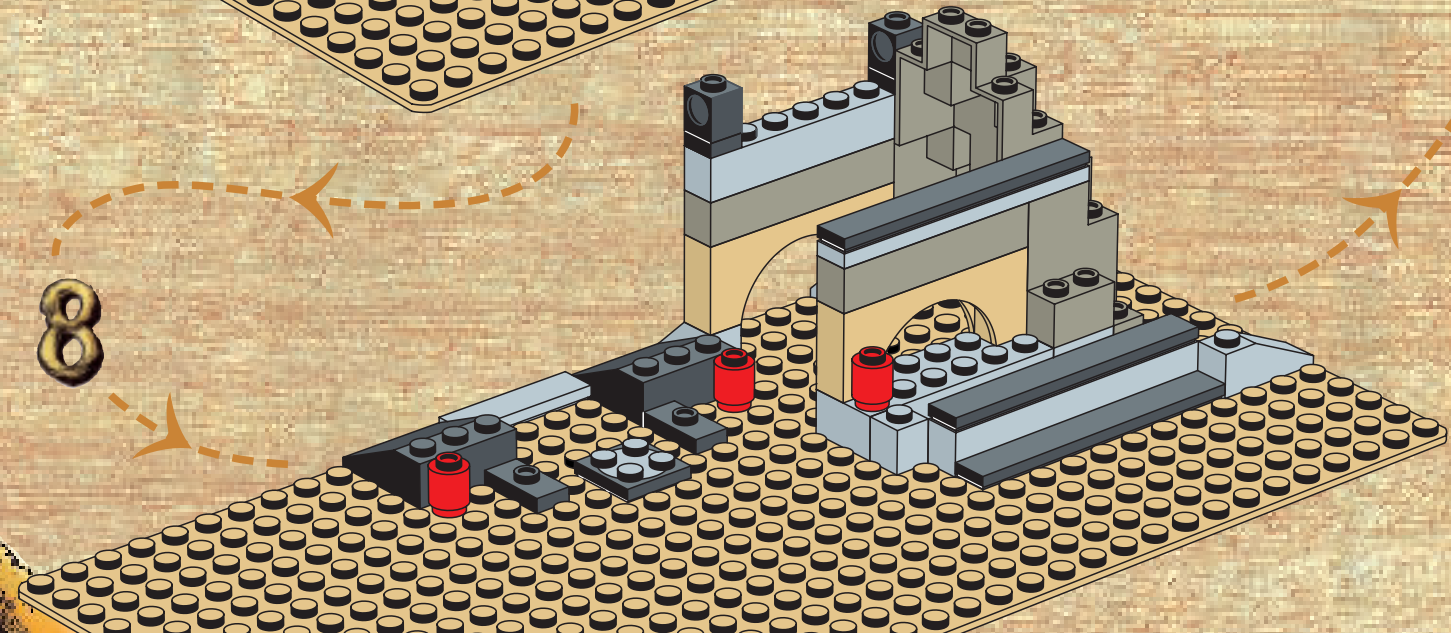
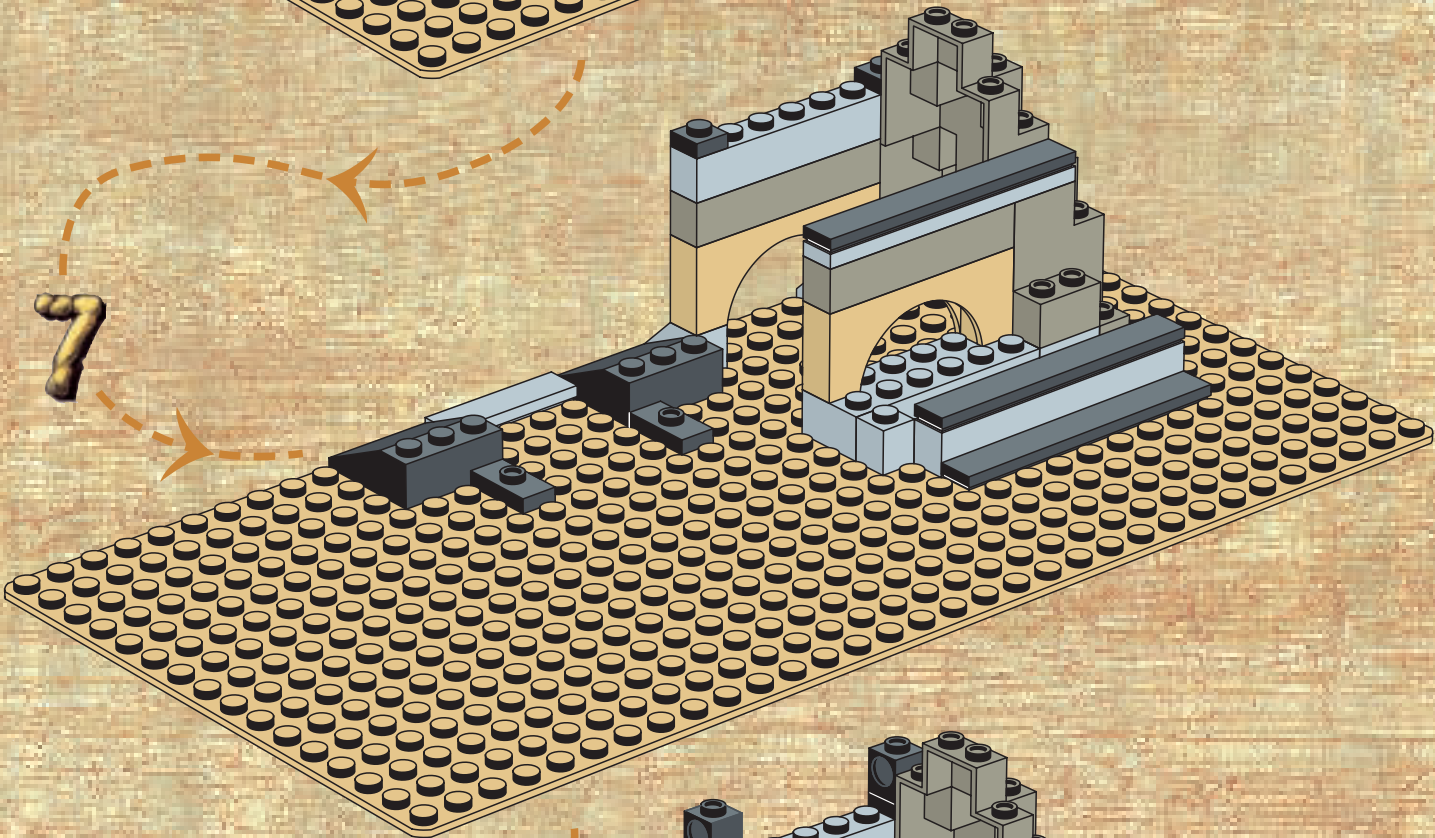
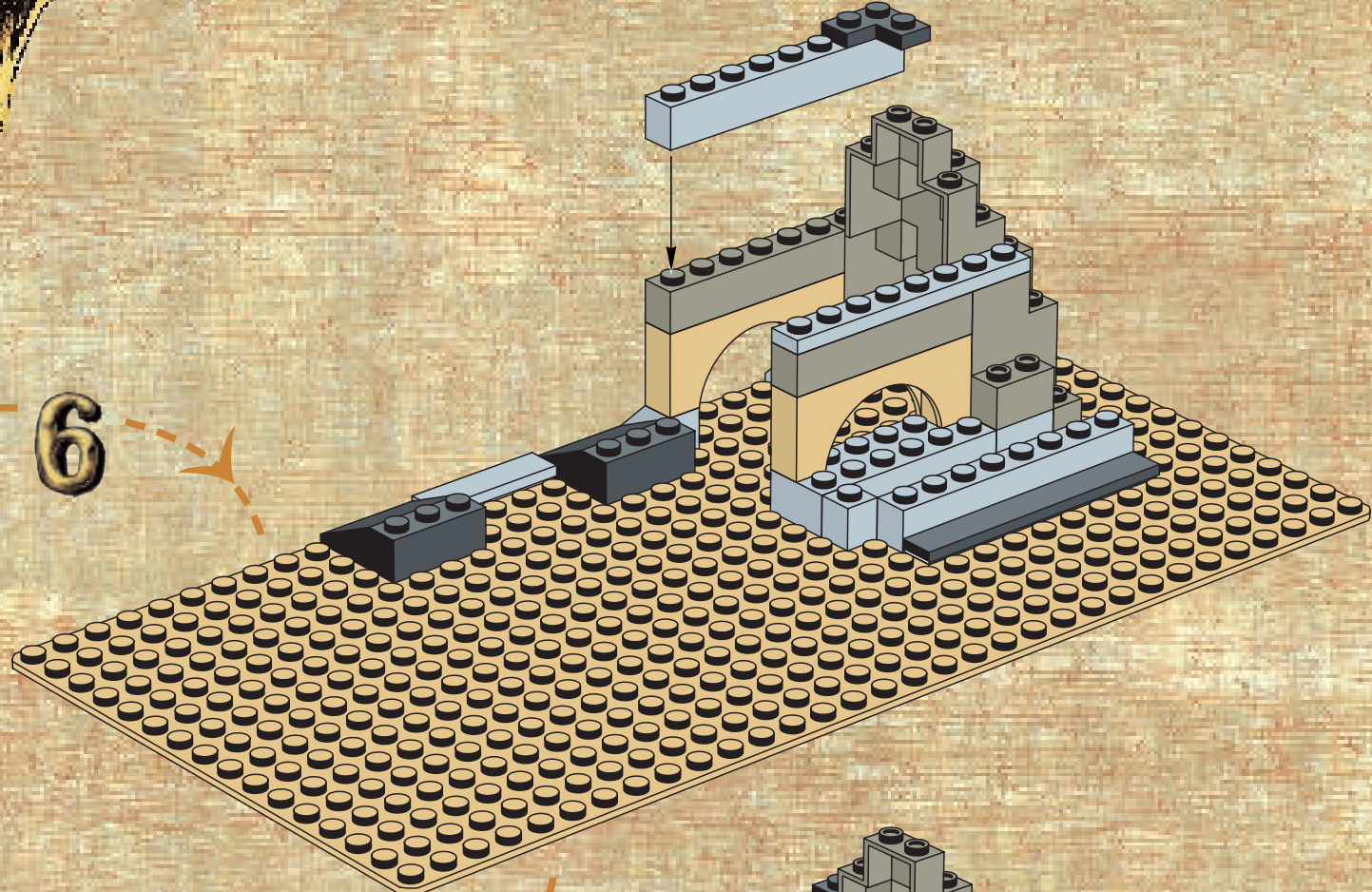



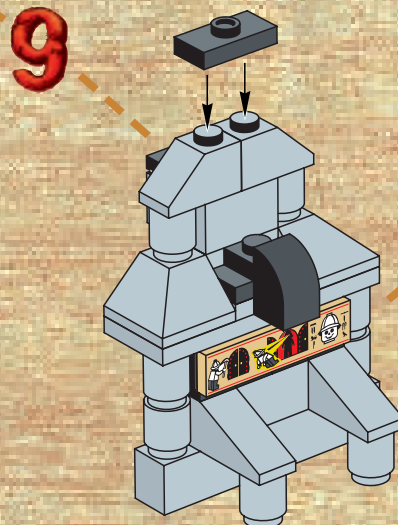
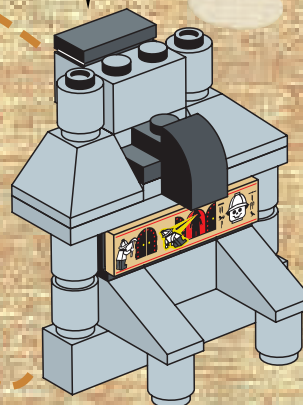
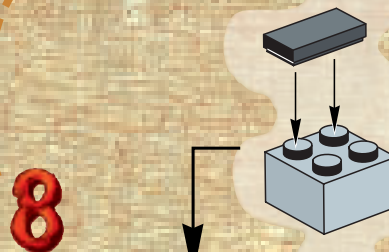
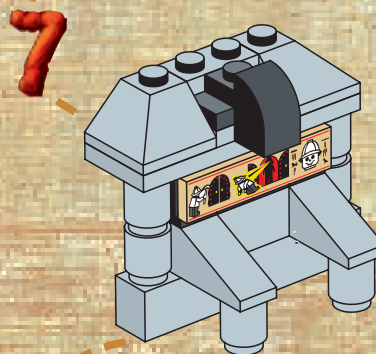
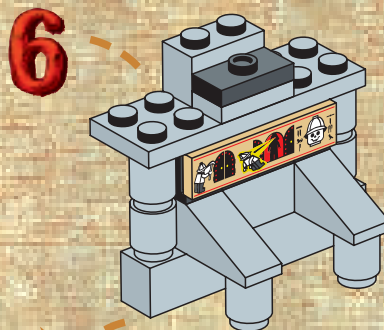
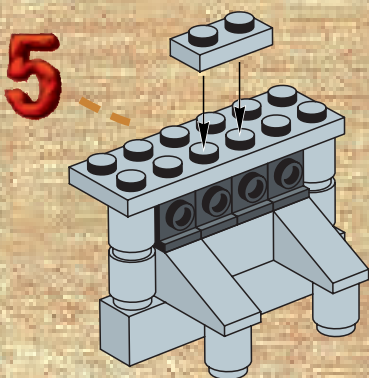
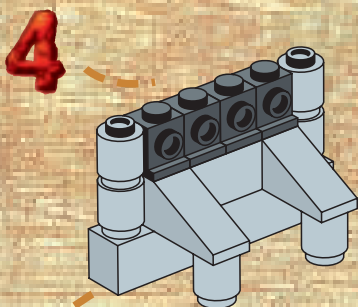
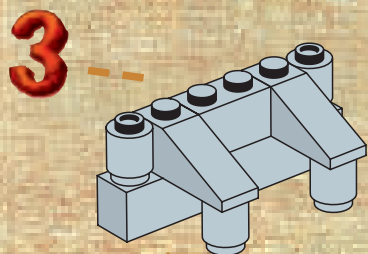
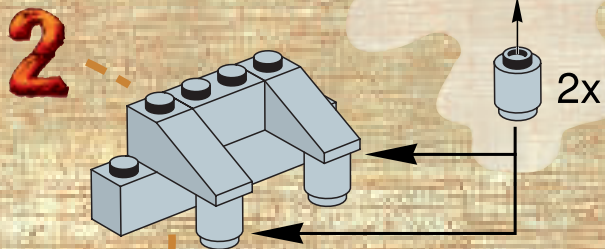
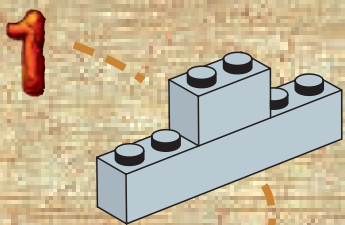



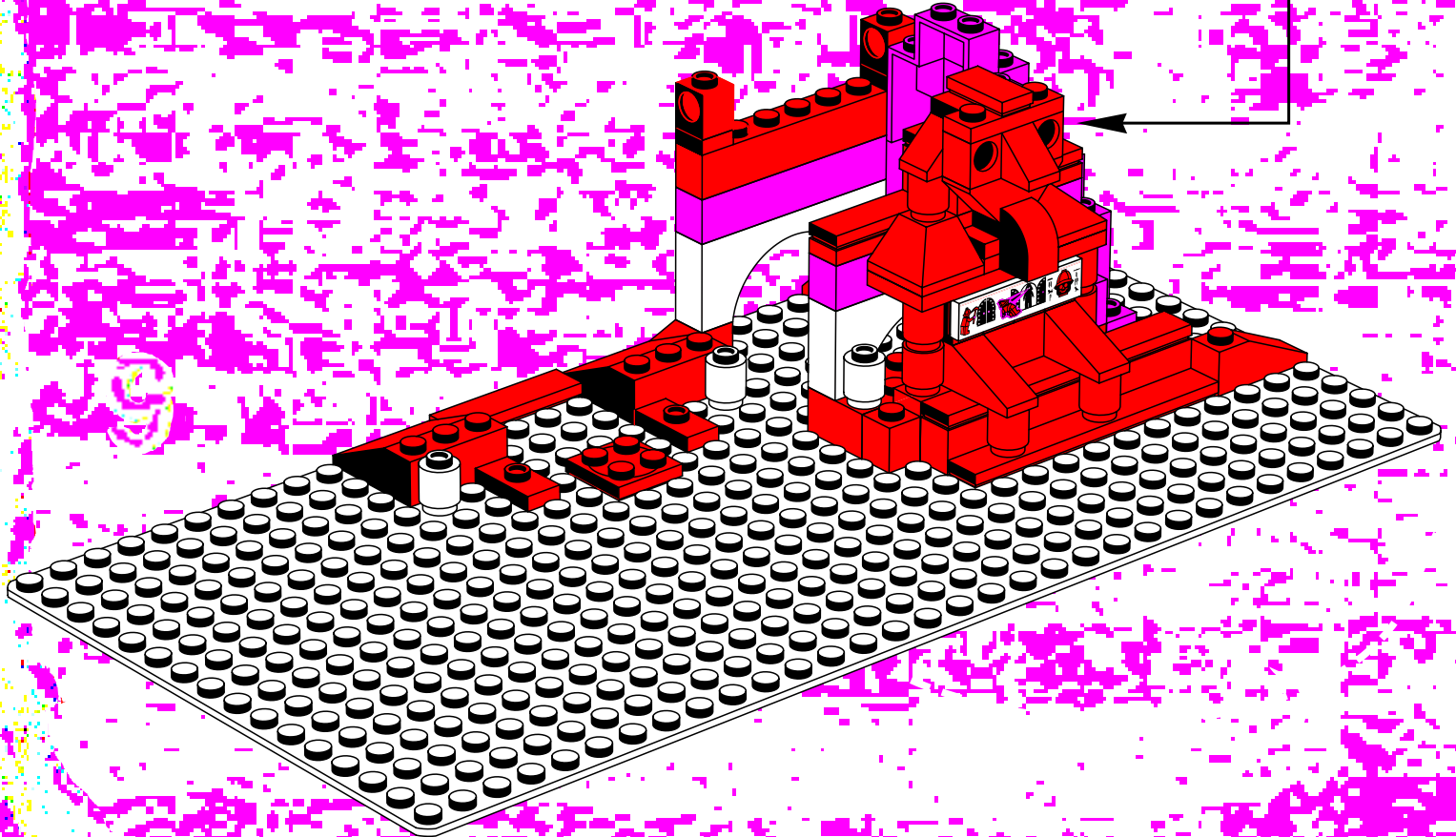
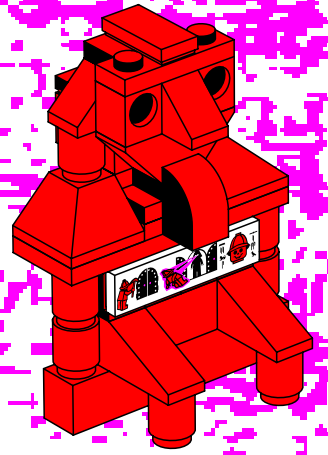
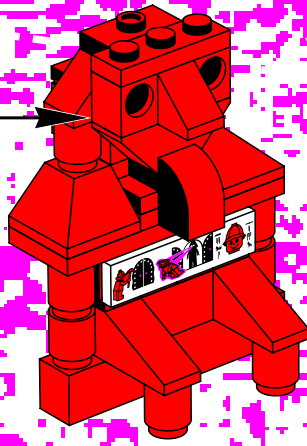
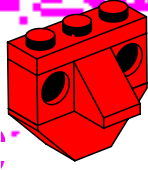
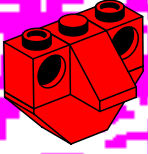
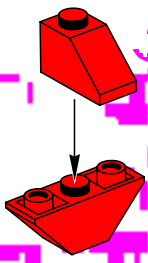



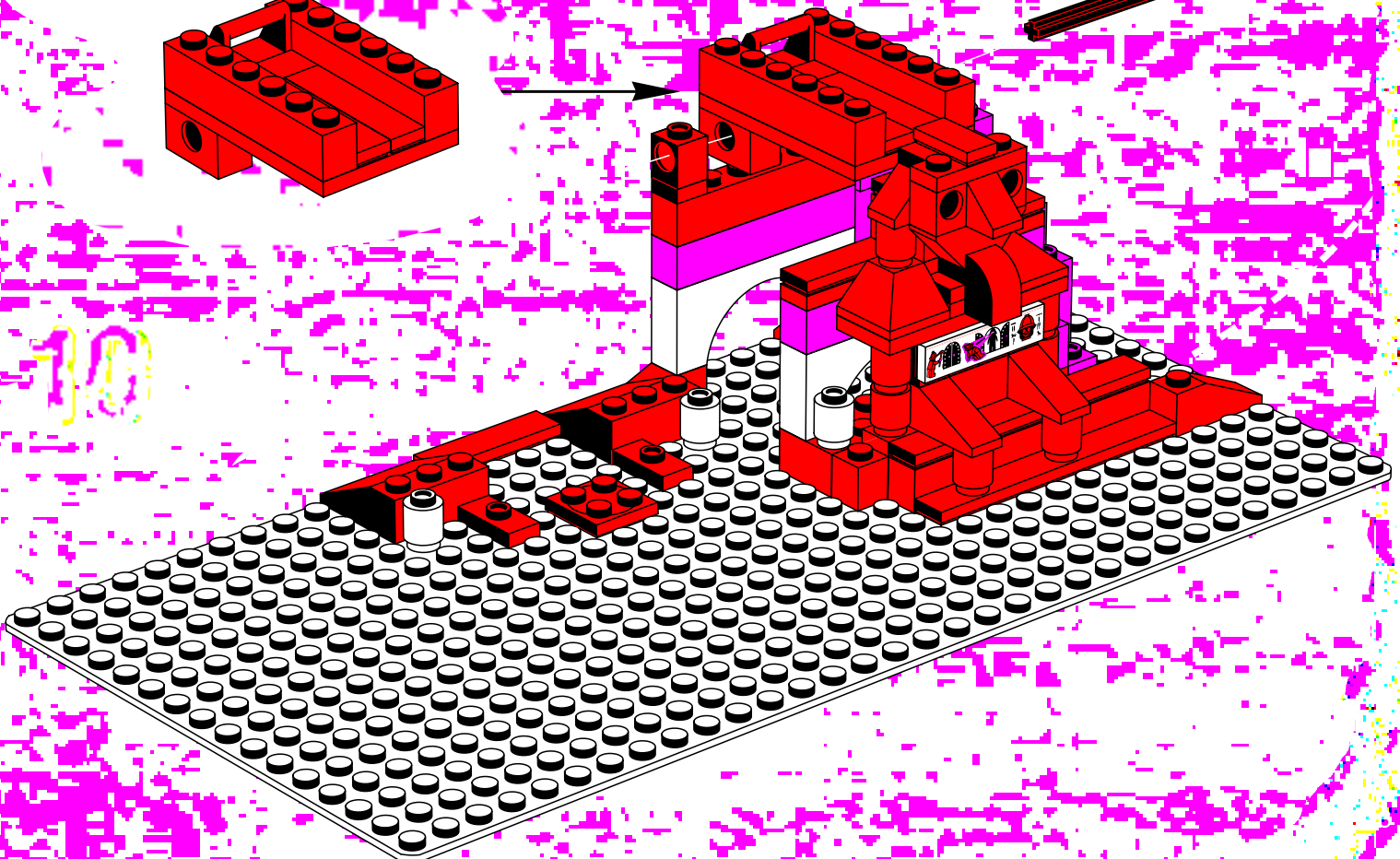
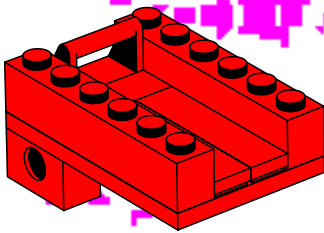
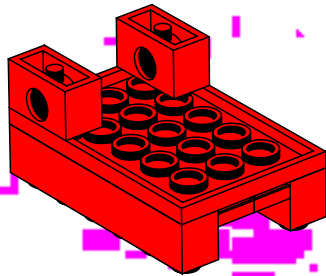
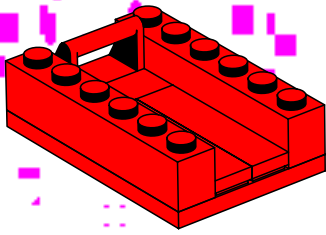
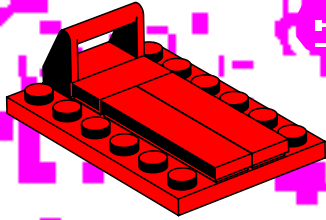
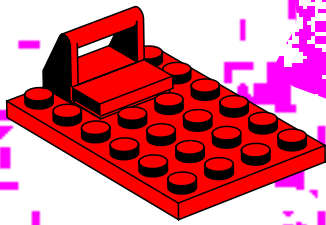

10



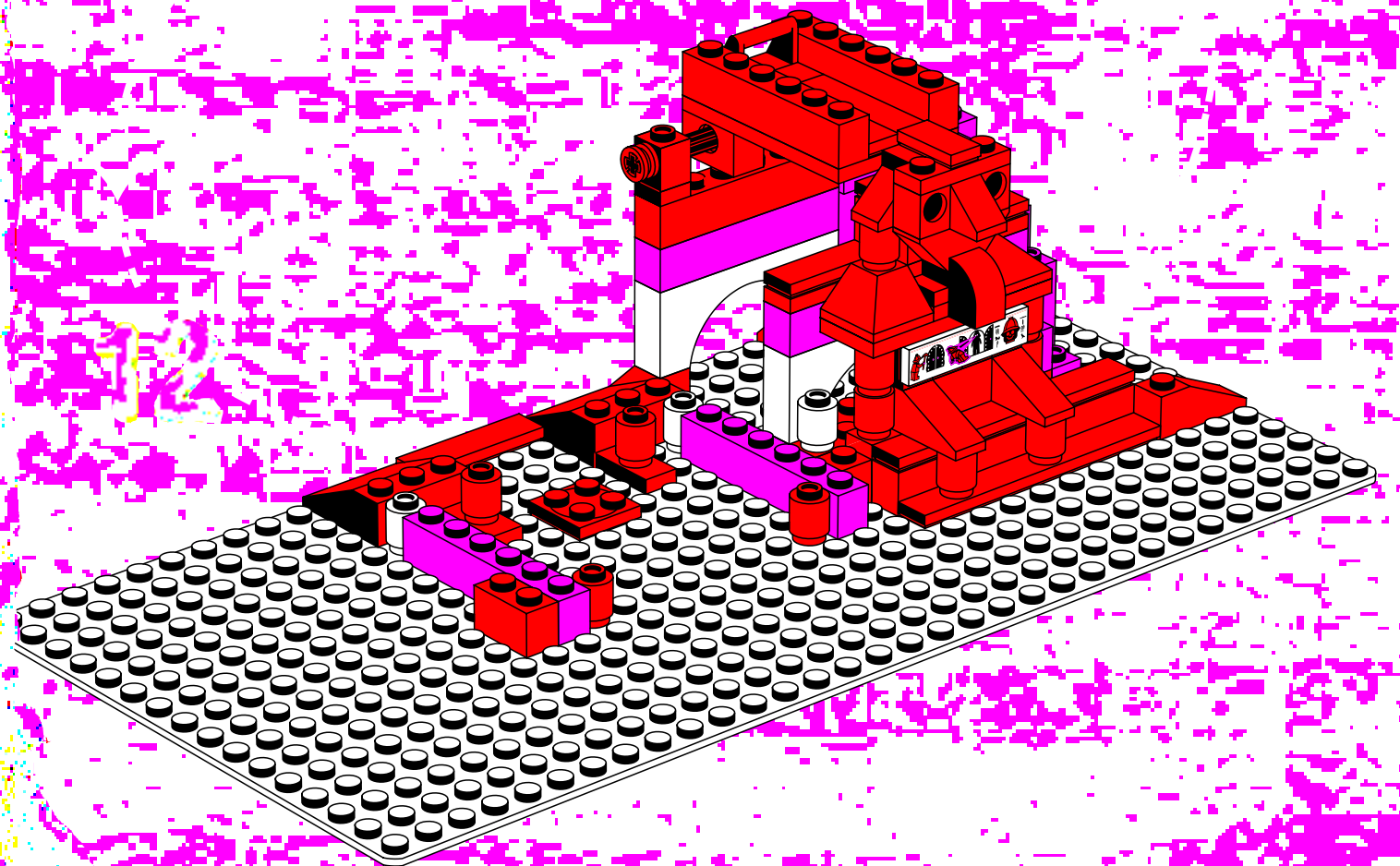
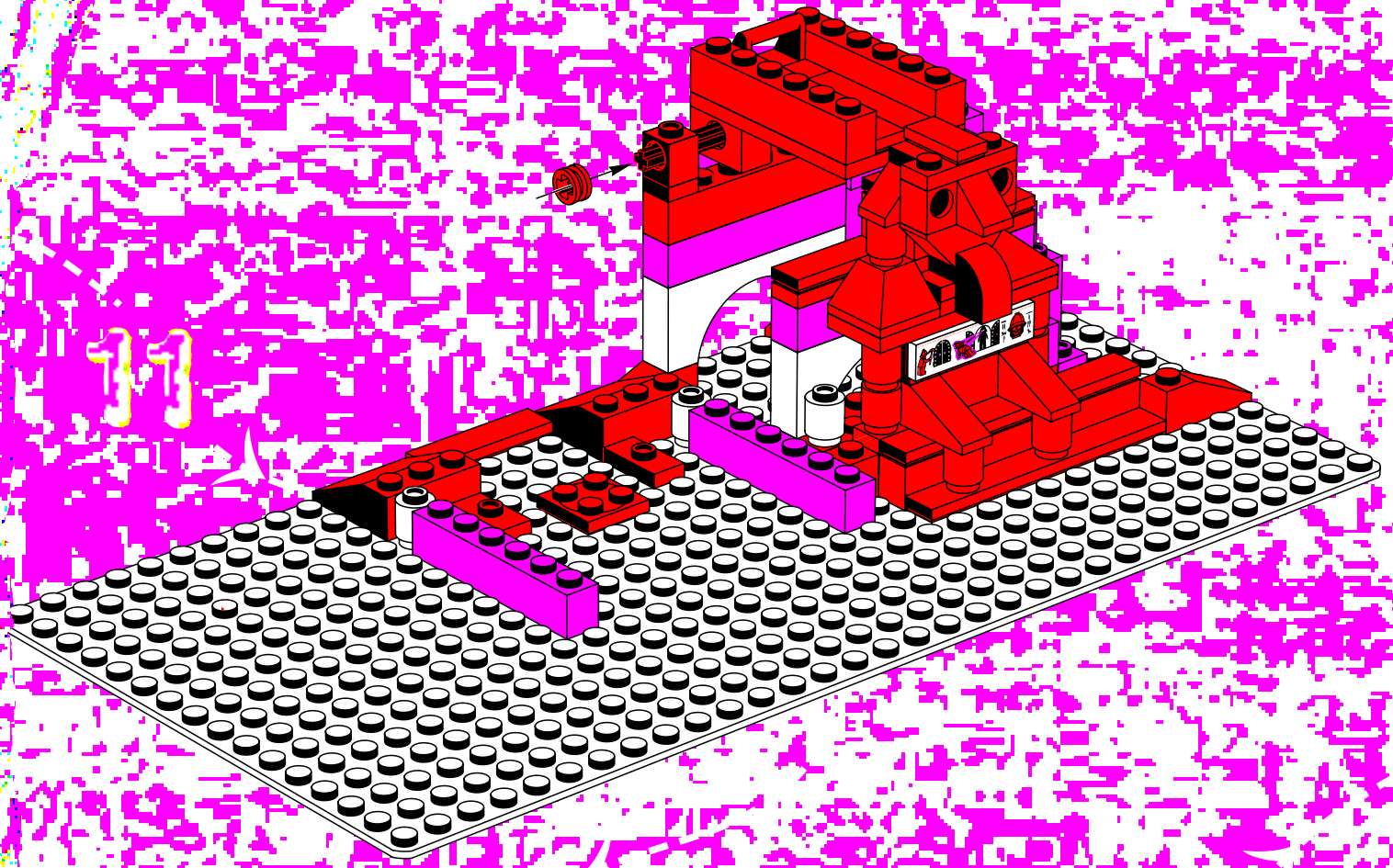



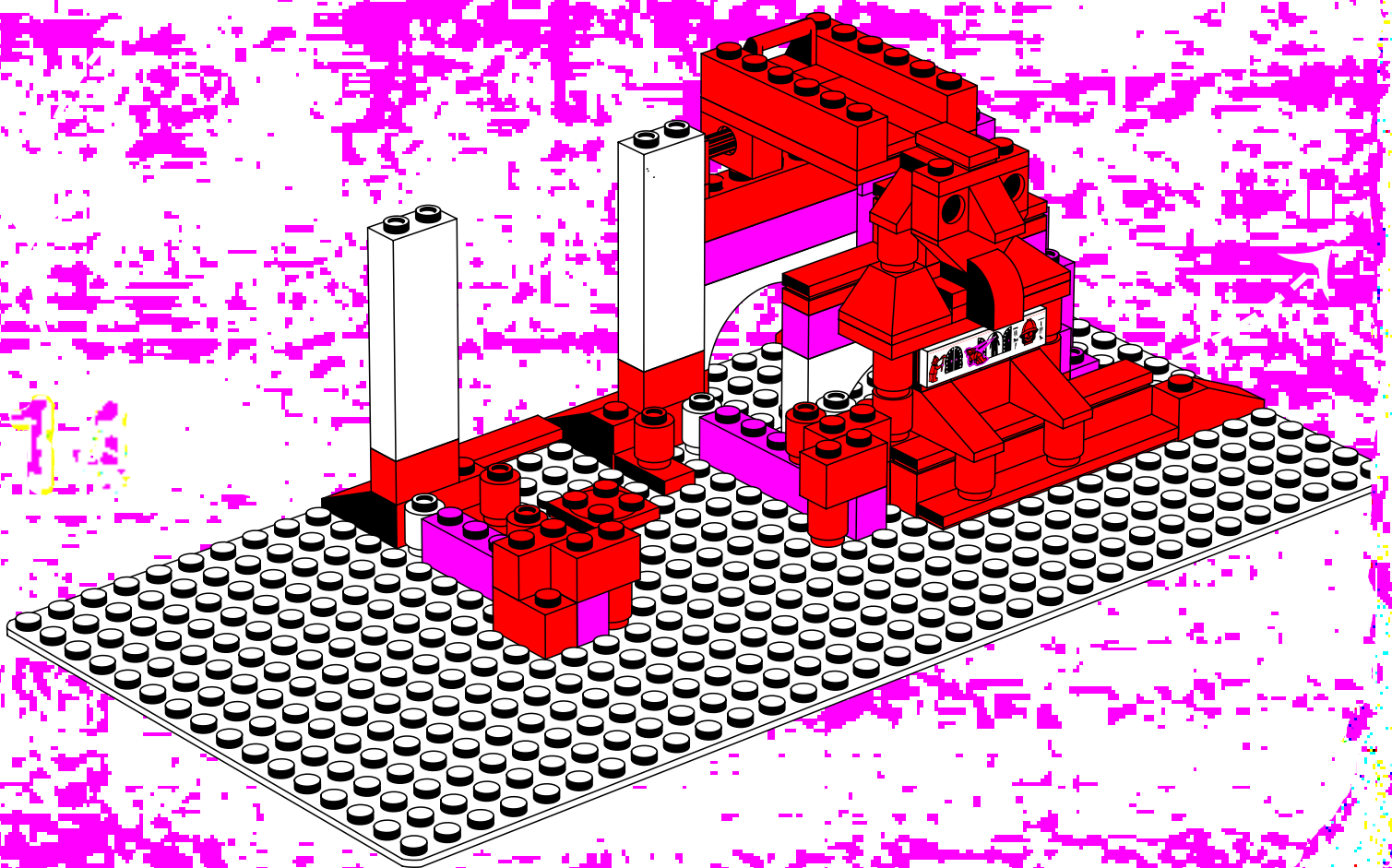
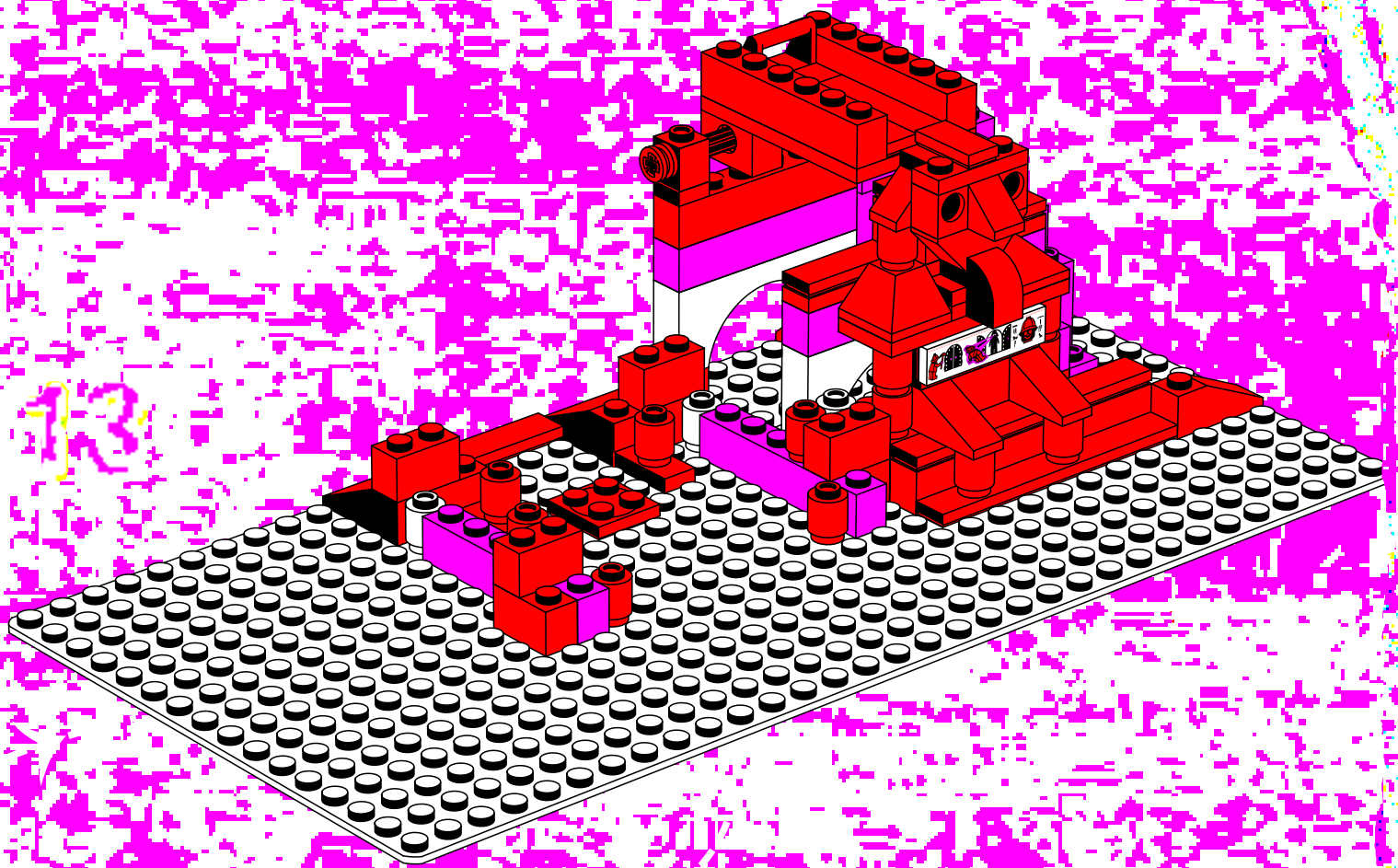



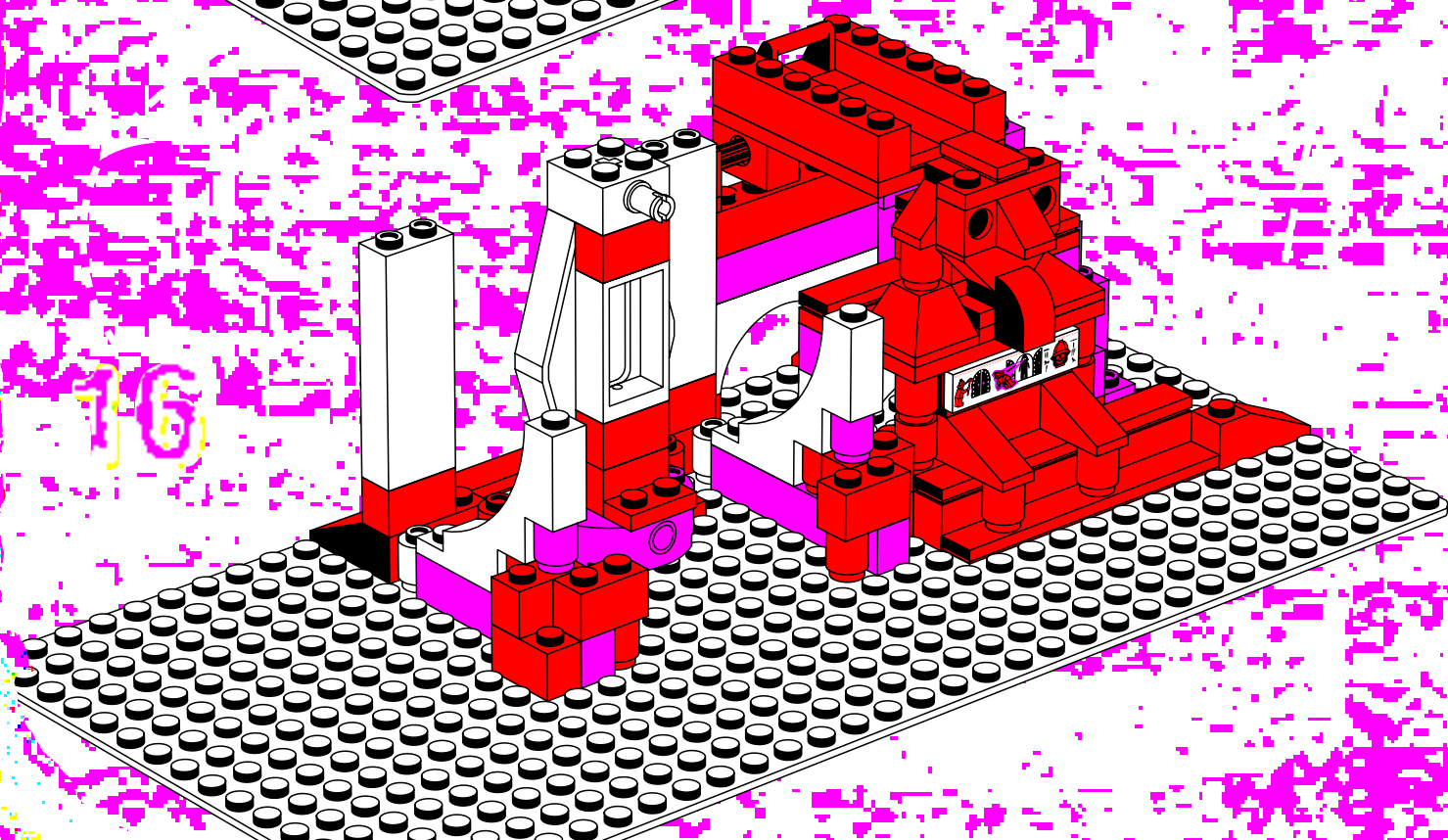
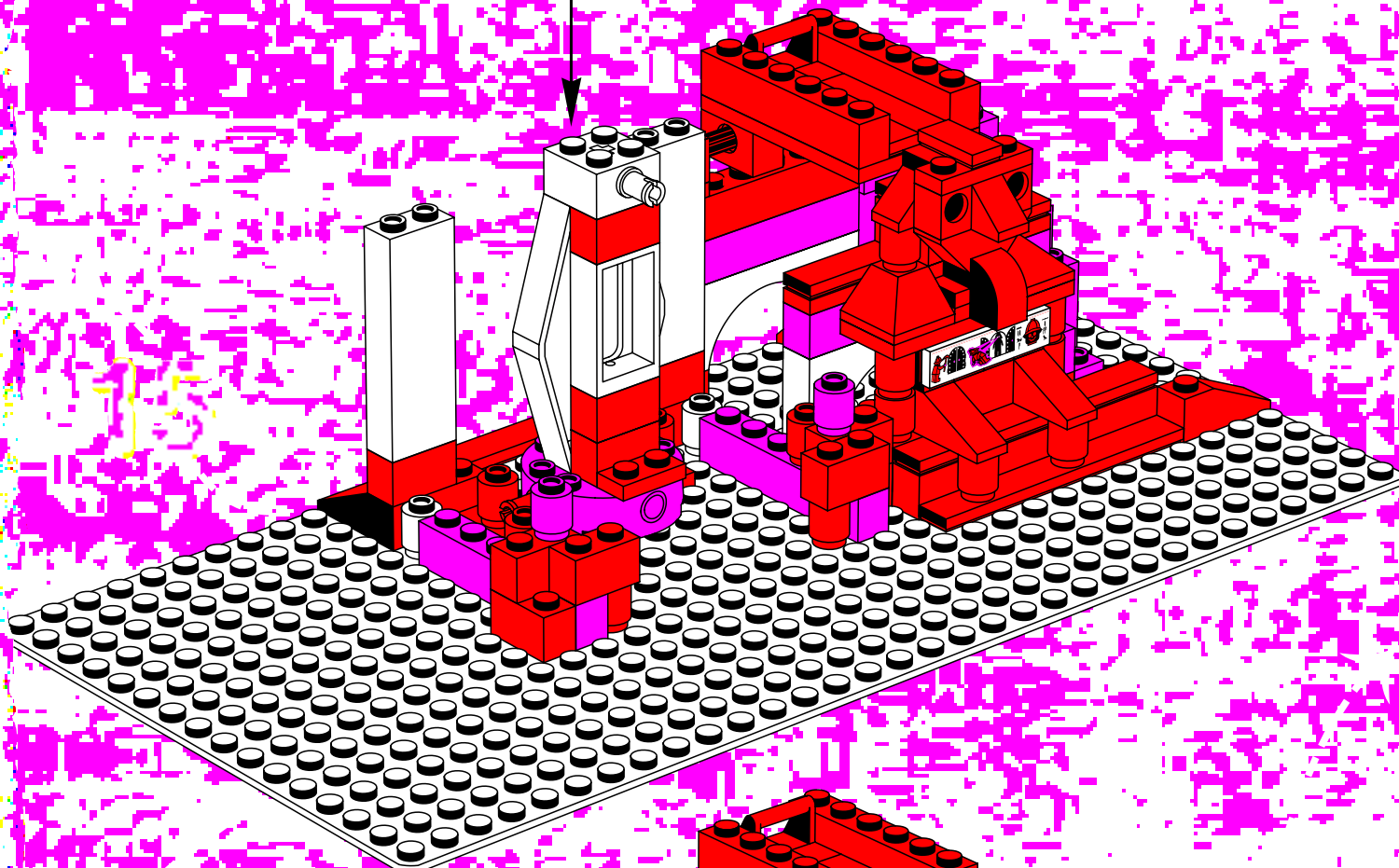
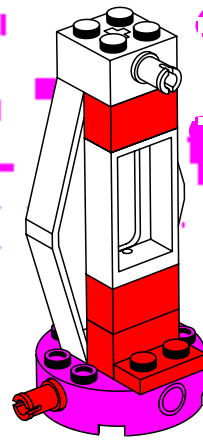
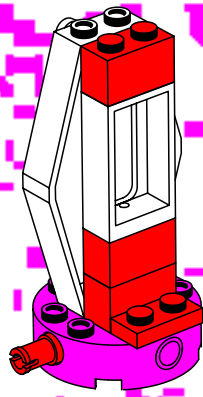
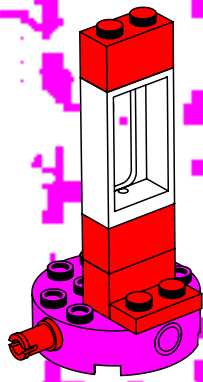
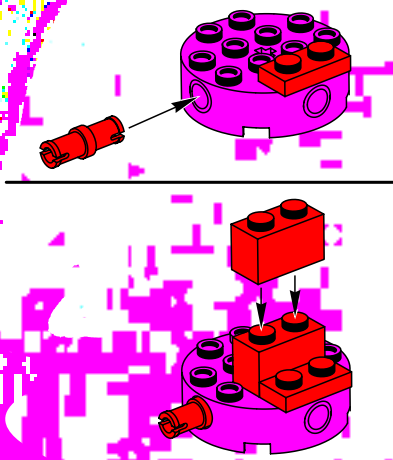

16

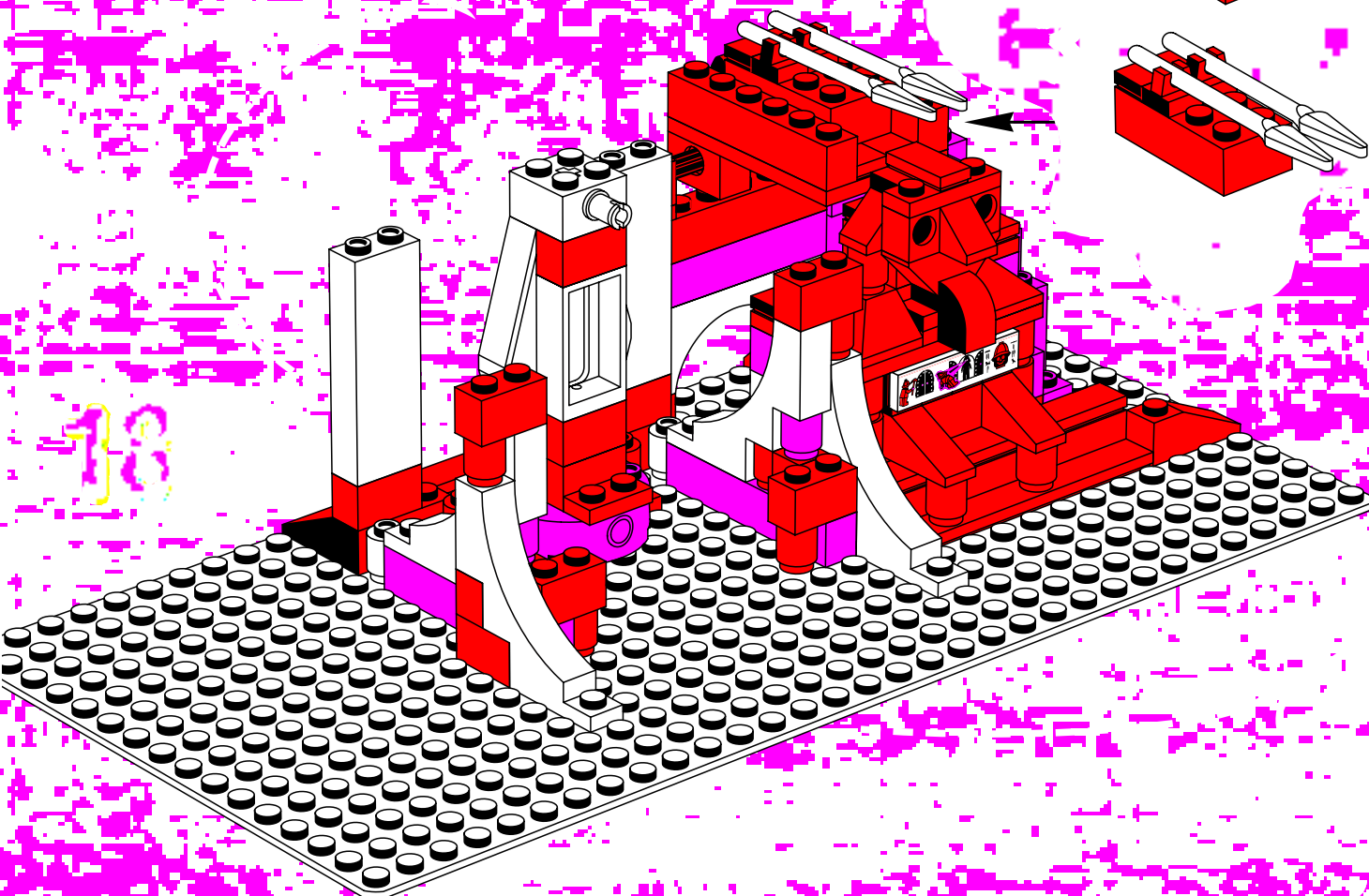
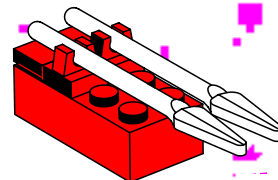
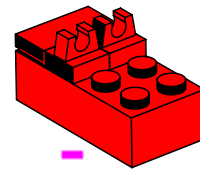
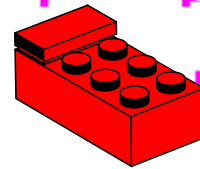
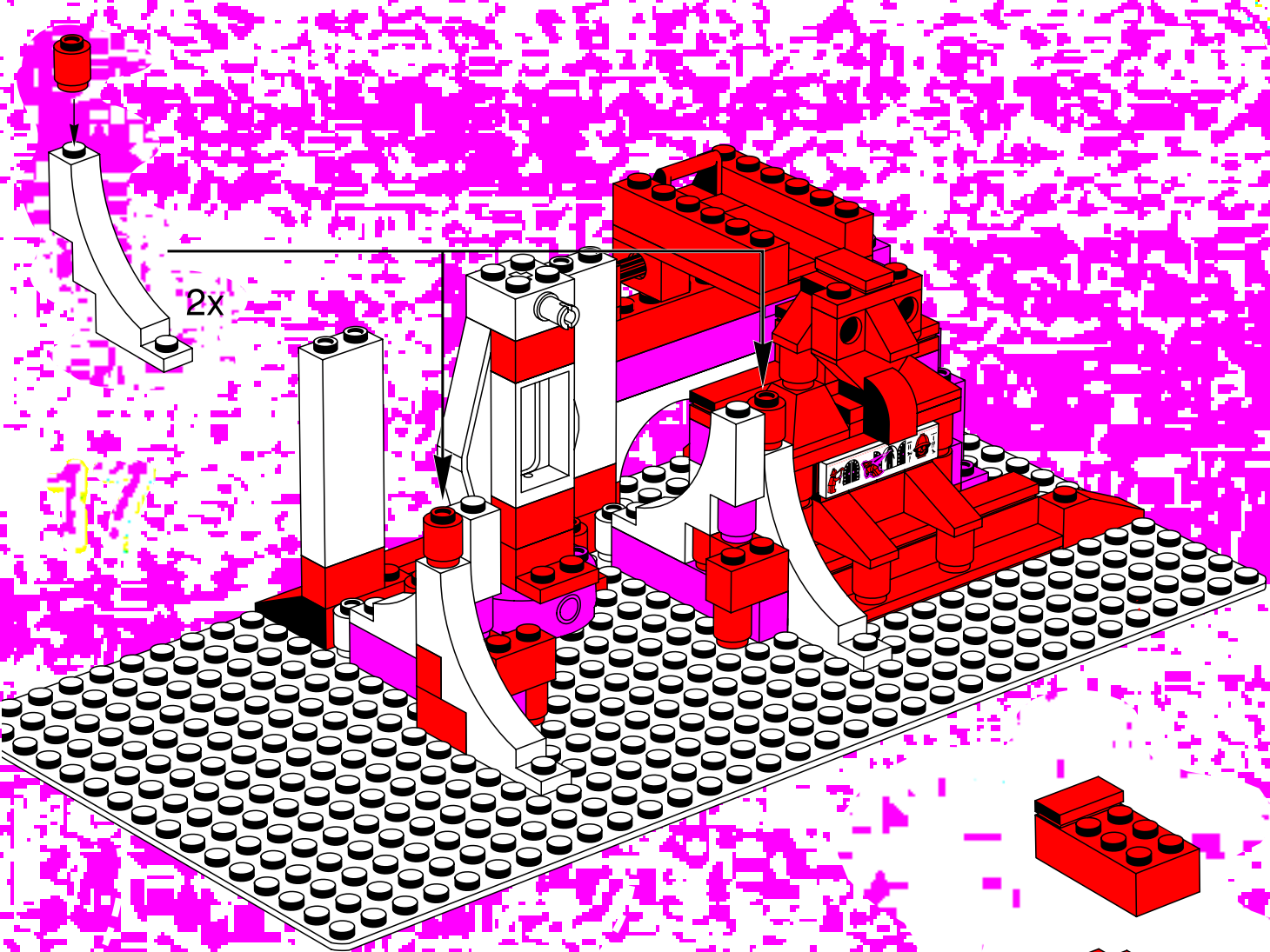



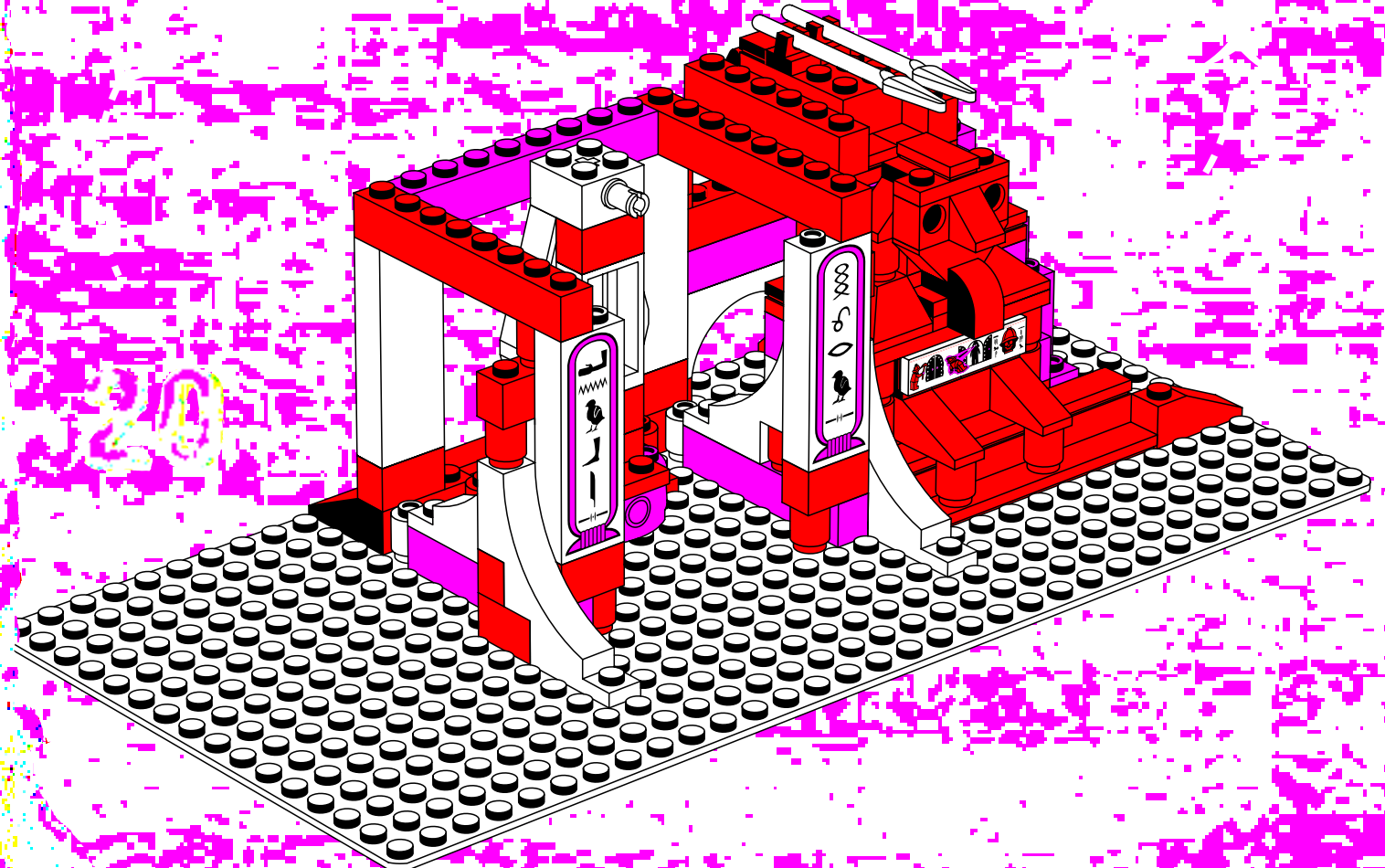
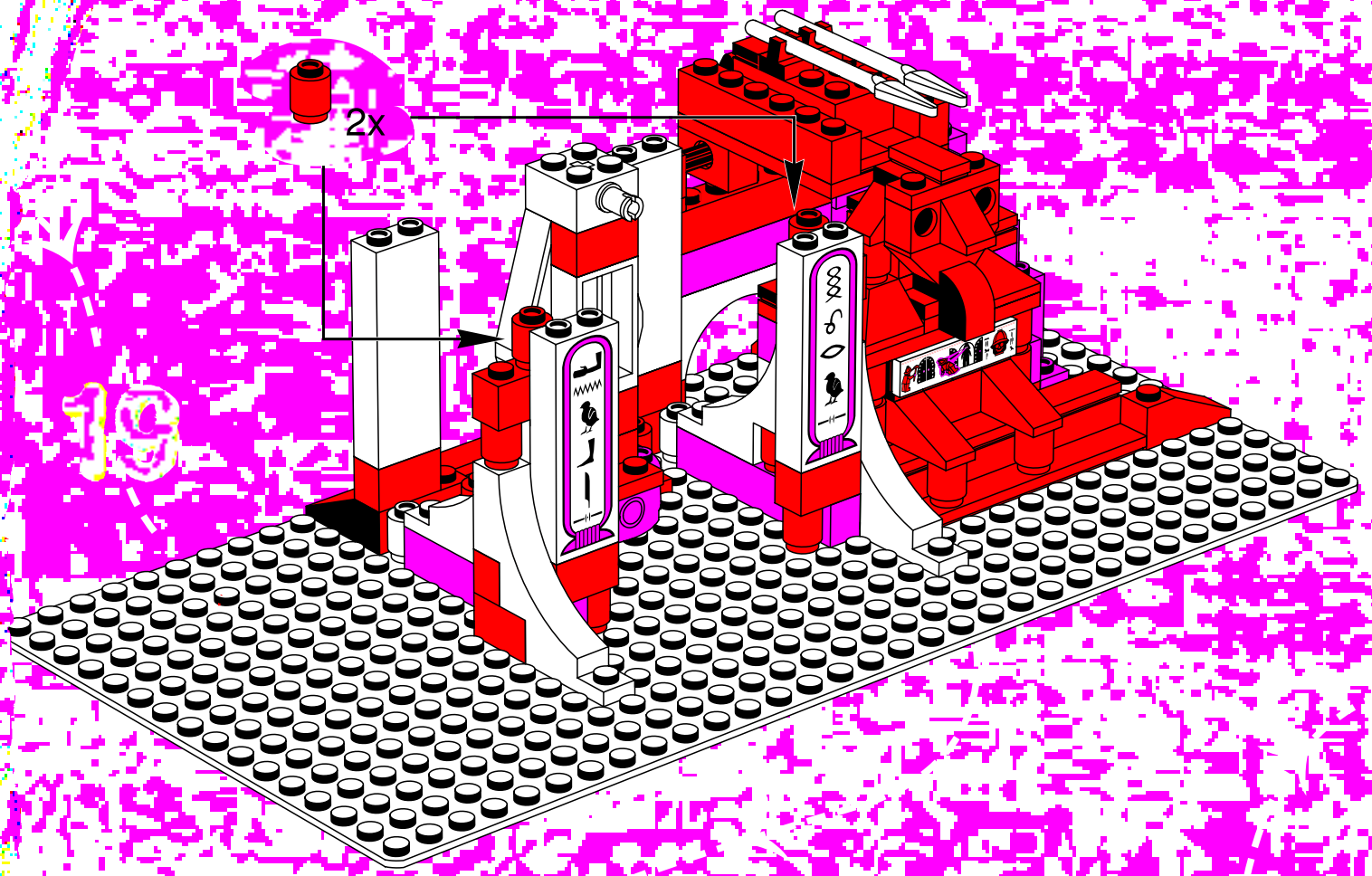

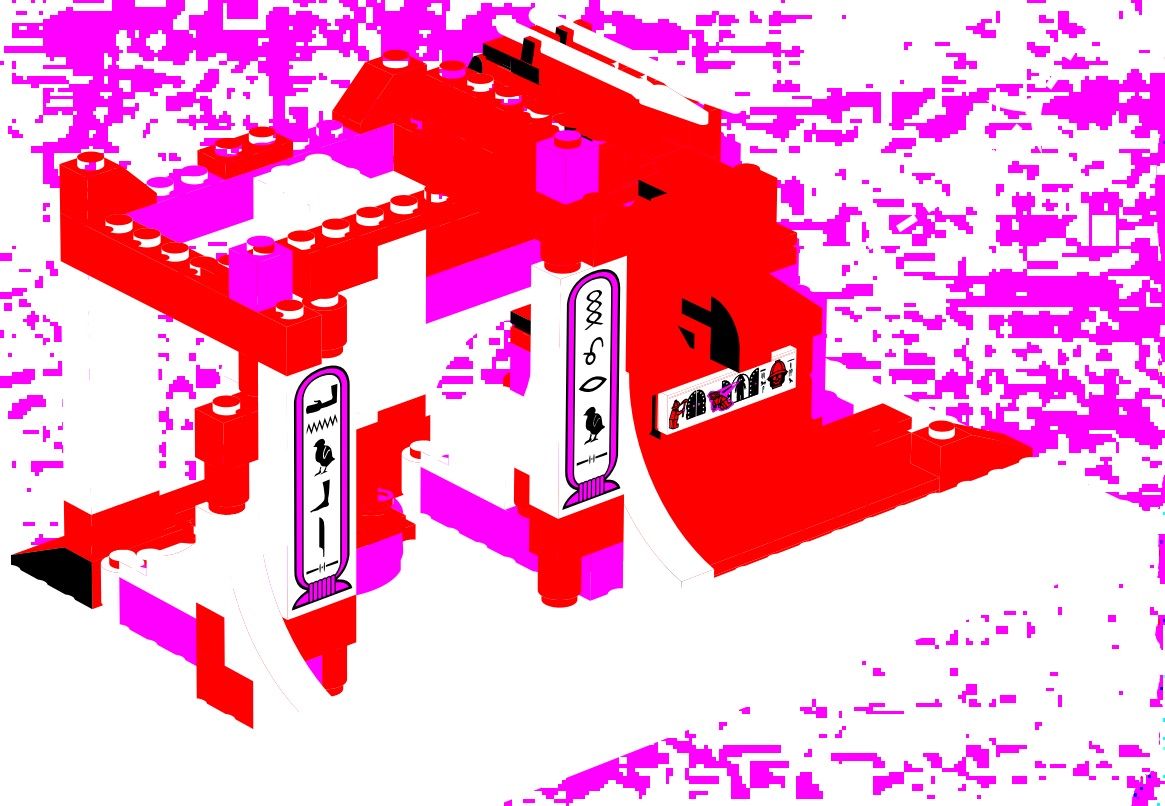
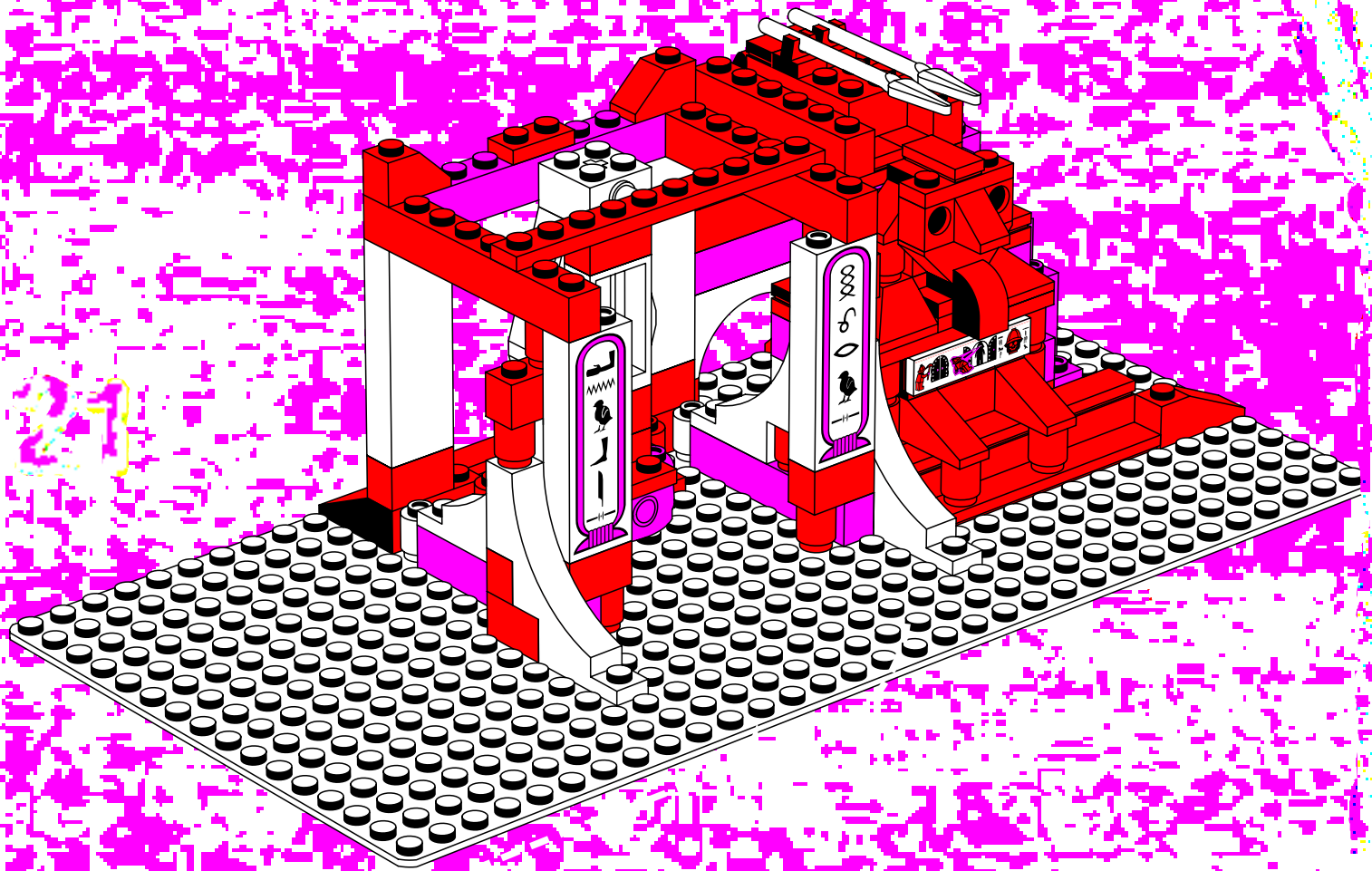



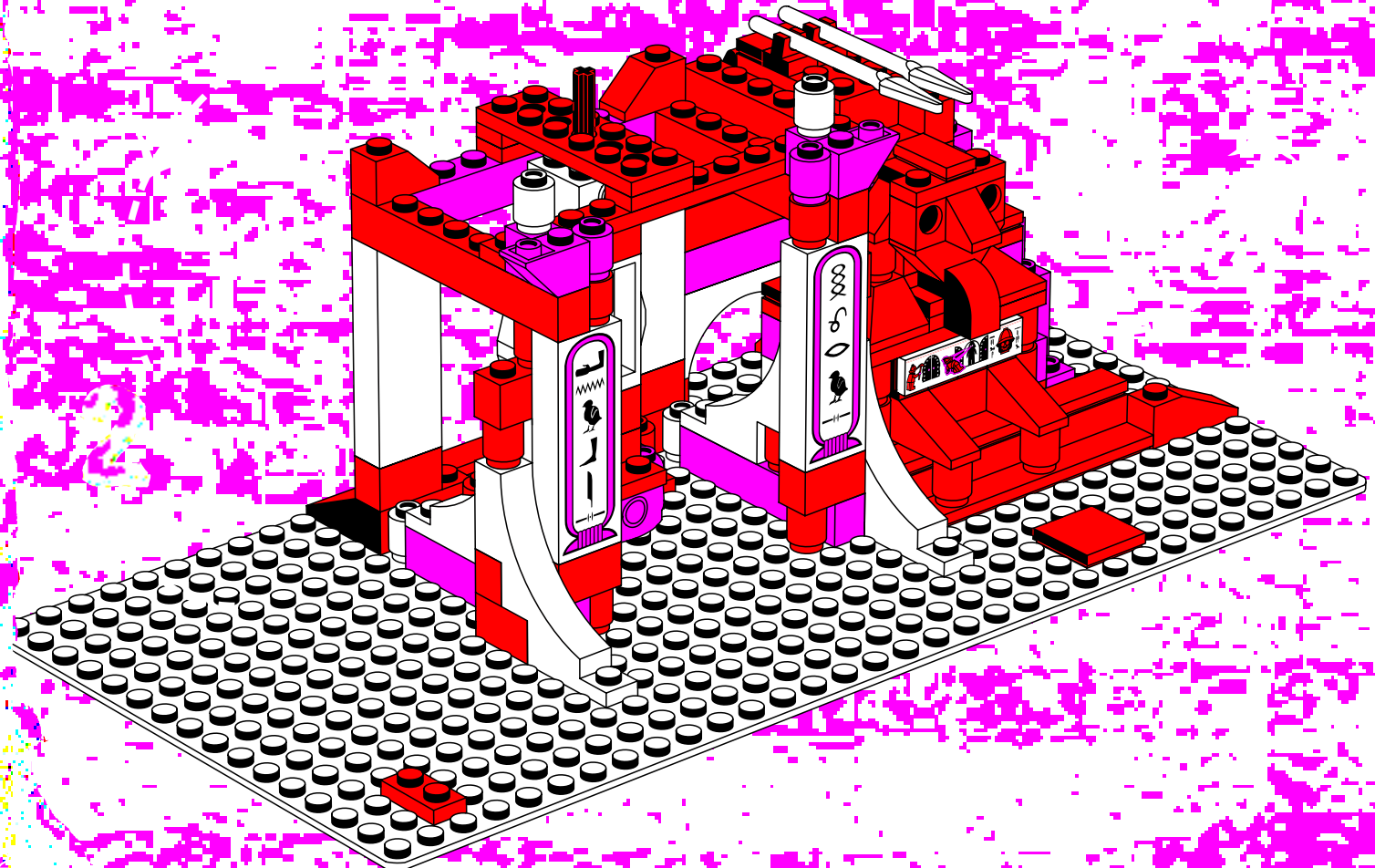
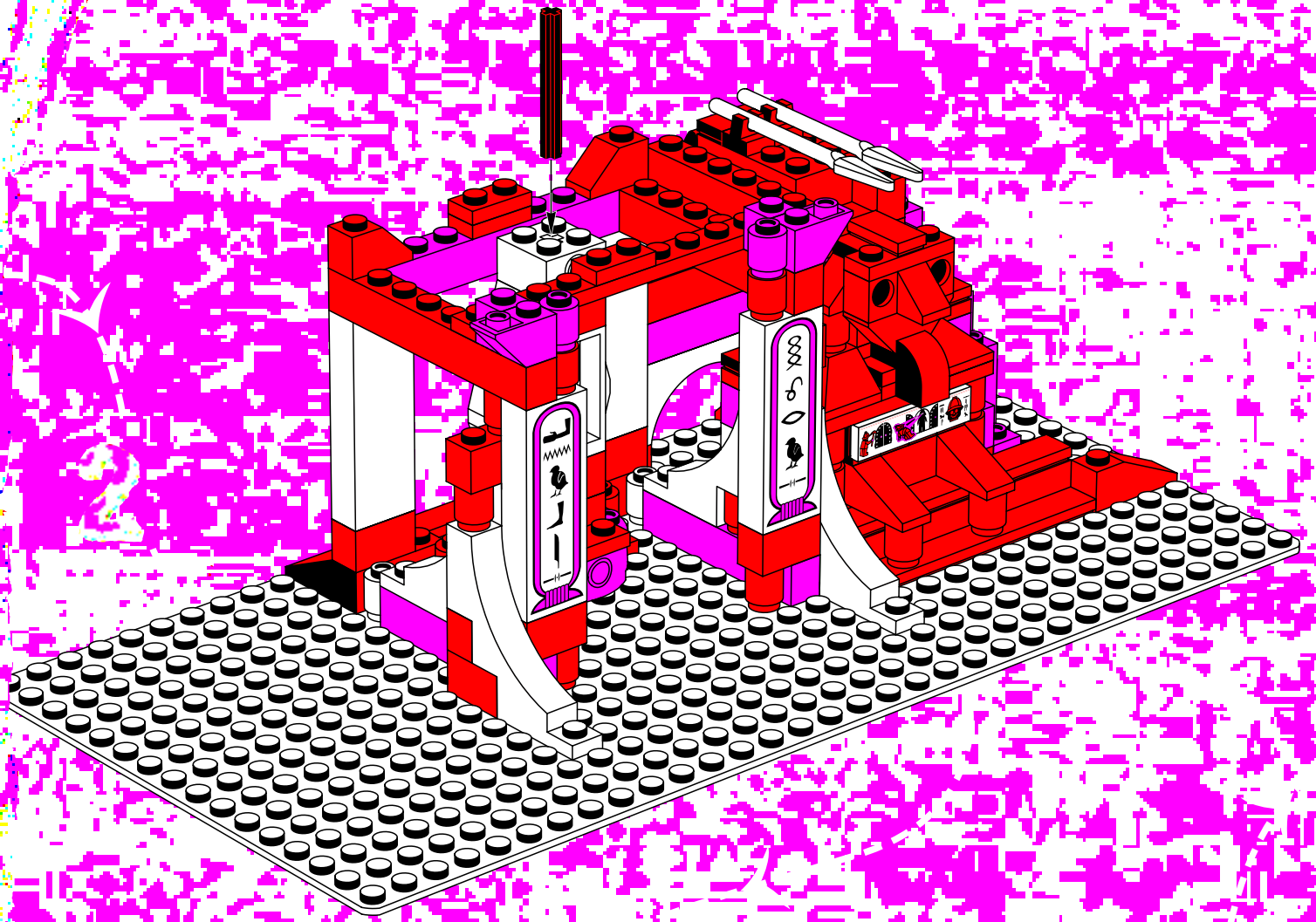

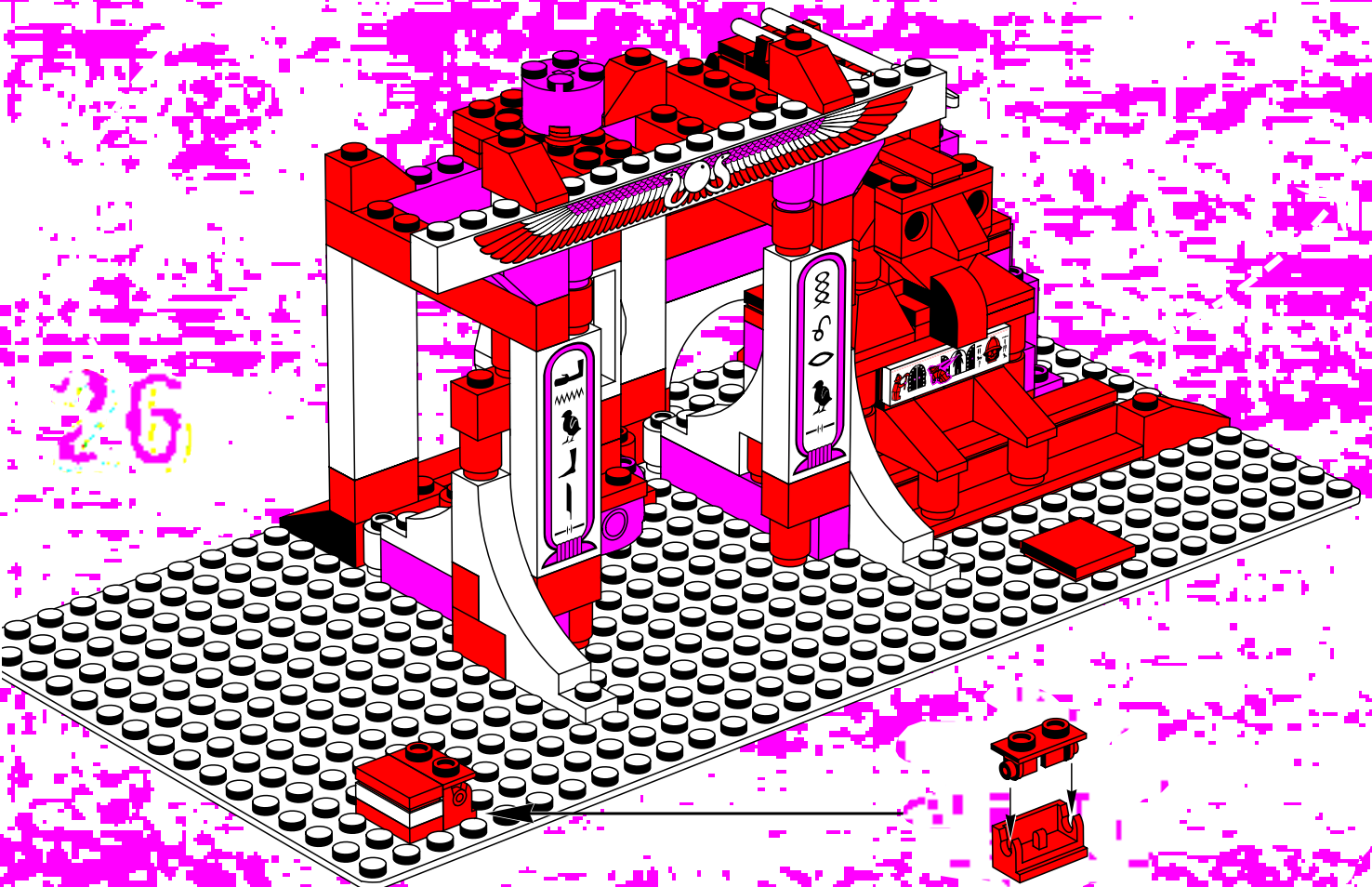
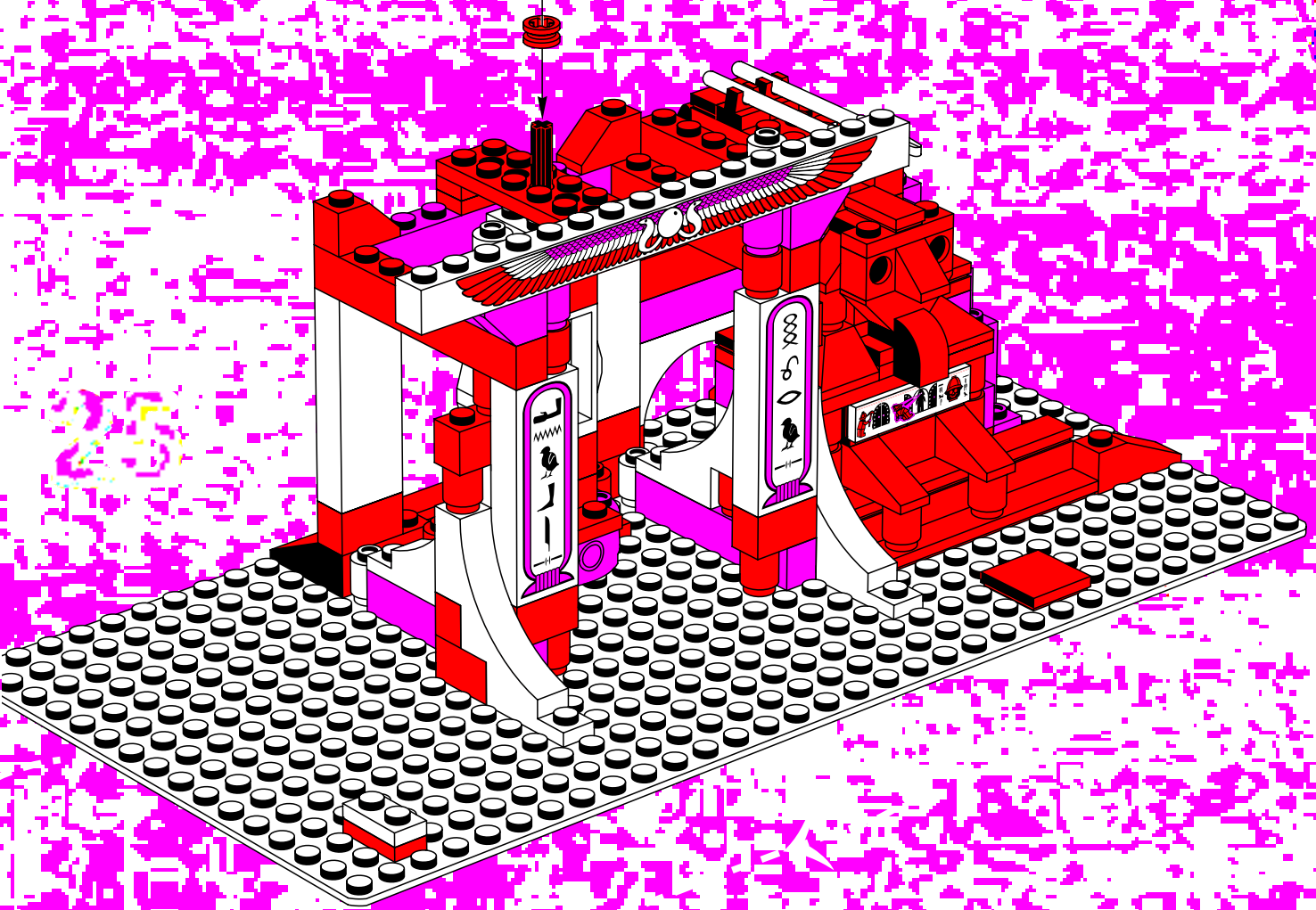

26



